

Oláj Ibolya

PSZICHOMOTORIKUS
GYAKORLATOK



FREE MEDIA

Újvidék - 2006

Előszó helyett

Útravaló

A boldogságot csak az bírja el, aki elosztja. A fény csak abban válik áldássá, aki másnak is ad belőle. Mert amikor bennünket elküldtek, az útrabocsájtó Hatalom így szólt:

Rád bízok minden embert külön, kivétel nélkül mindenkit, segíts, adj enni, adj ruhát, mindenkire vigyázz úgy, mint magadra, és ne hagyd a sötétségben elmerülni. Amit szerzel, amit elérsz, amit tudsz, amit átélsz, osszad meg. Az egész világ a tiéd. Szabad vagy a kövektől az éterig. Ismerd meg, hódítsd meg, senki se tiltja, de jaj neked, ha magadnak tartod. Elbocsátlak téged is, mint mindenkit: felelős vagy minden emberért, aki veled él, s el kell számolnod minden fillérrel, amit magadra költesz, minden örömmel, amit magadba zártál, és minden boldog pillanattal, amit magadnak tartottál meg. Most eredj és élj, mert a világ a tiéd.

(Hamvas Béla)



Rajzold hullámvonalakat!

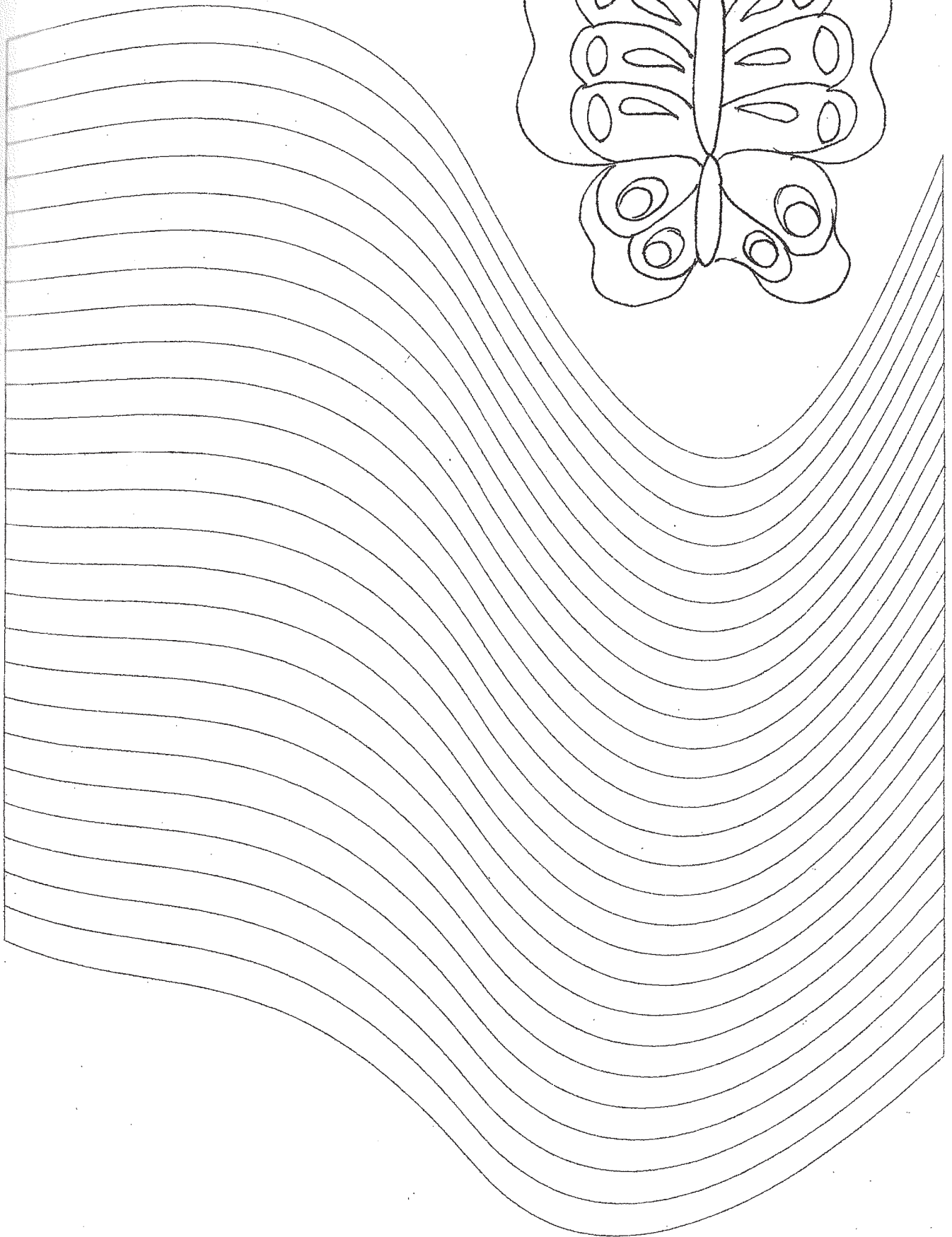
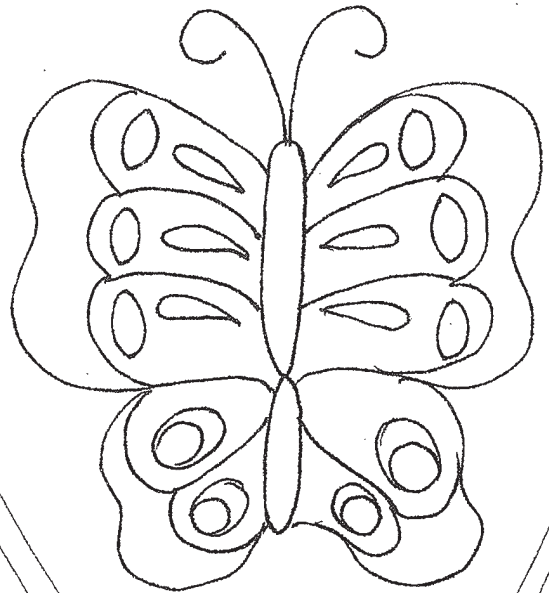

Kösd össze az egymással szemben lévő fehér és fekete pontokat!



Rajzolj köröket növekvő sorrendben!

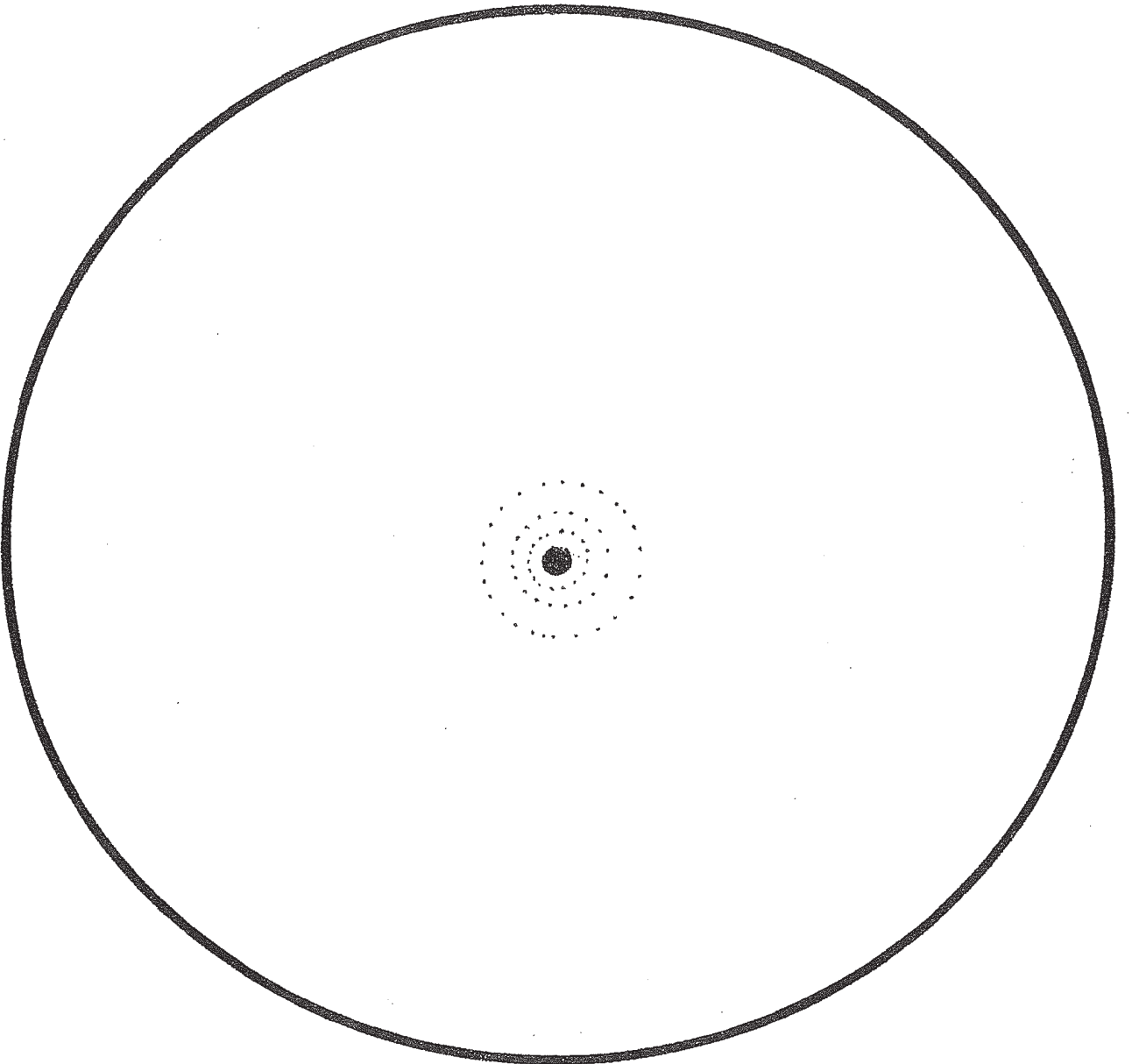

Színezd a vonalak közötti területeket különböző színűre!

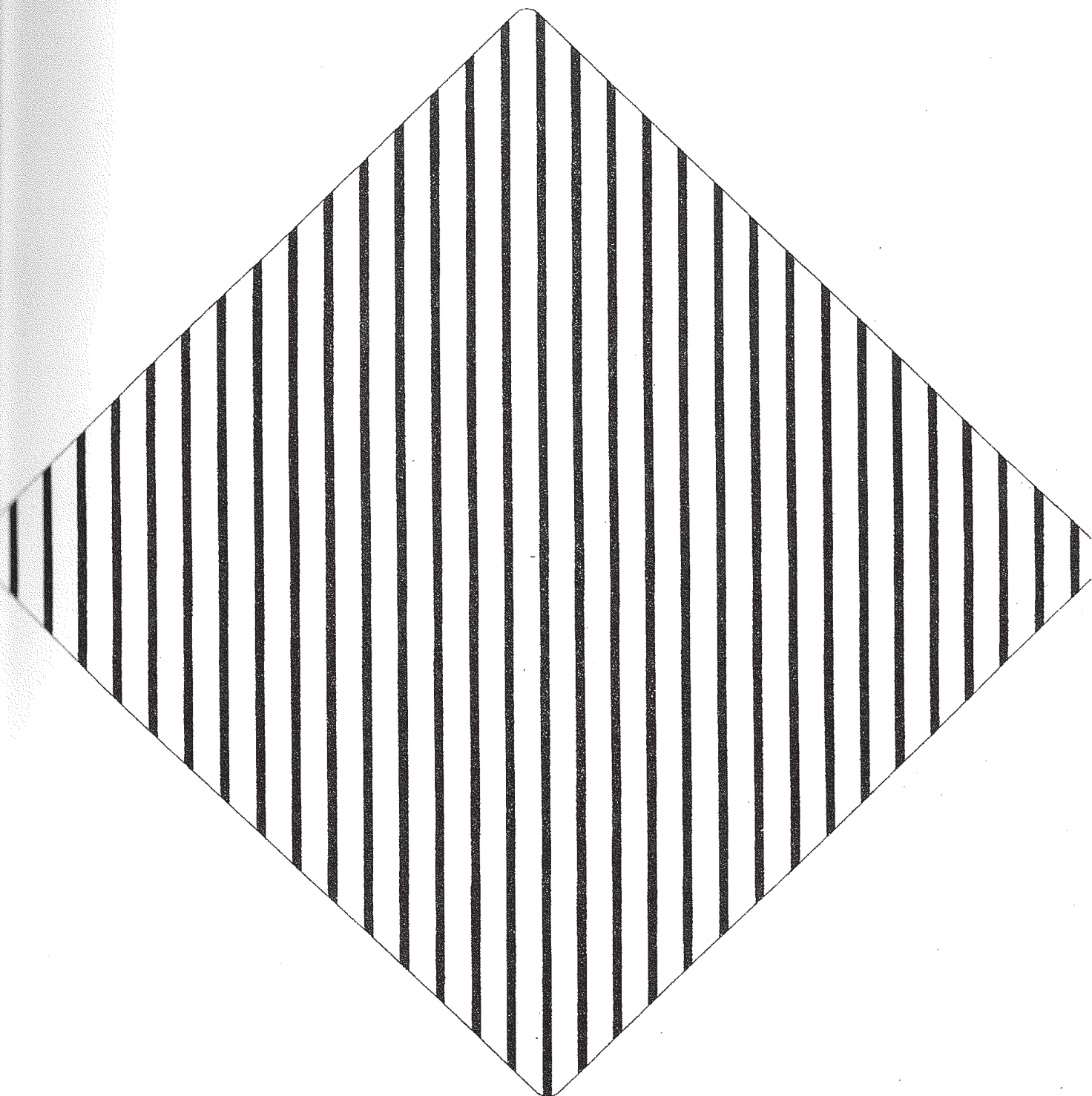

Húzz vonalat a spirál középpontjáiig jobb kézzel, majd bal kézzel!

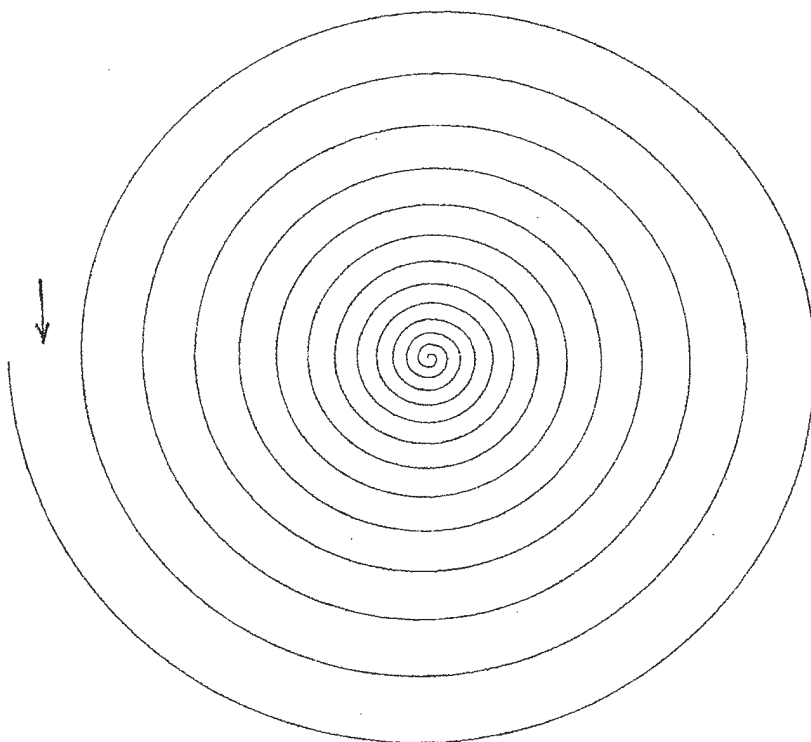
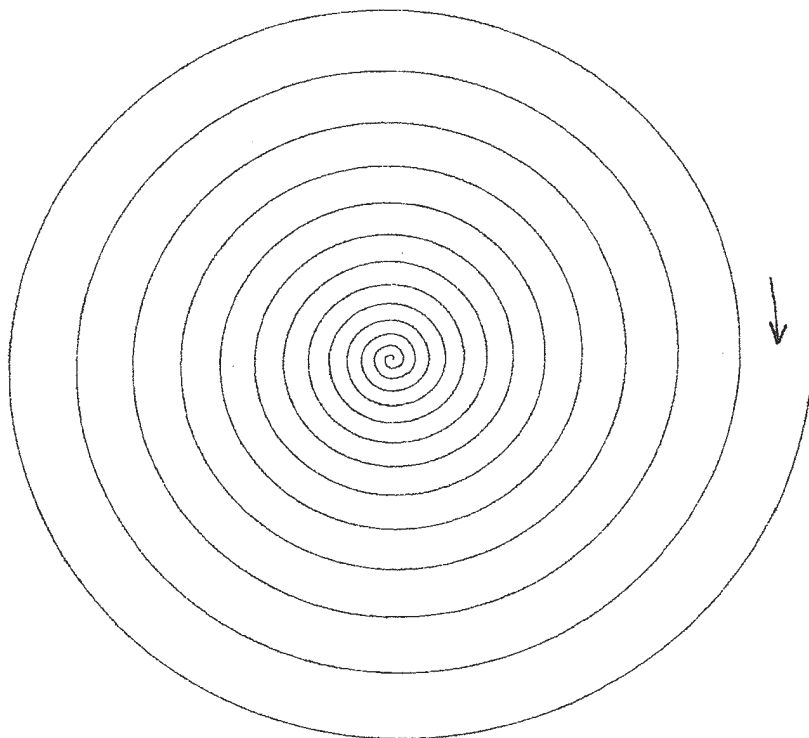

Rajzolj leveleket a fára és színezd ki!

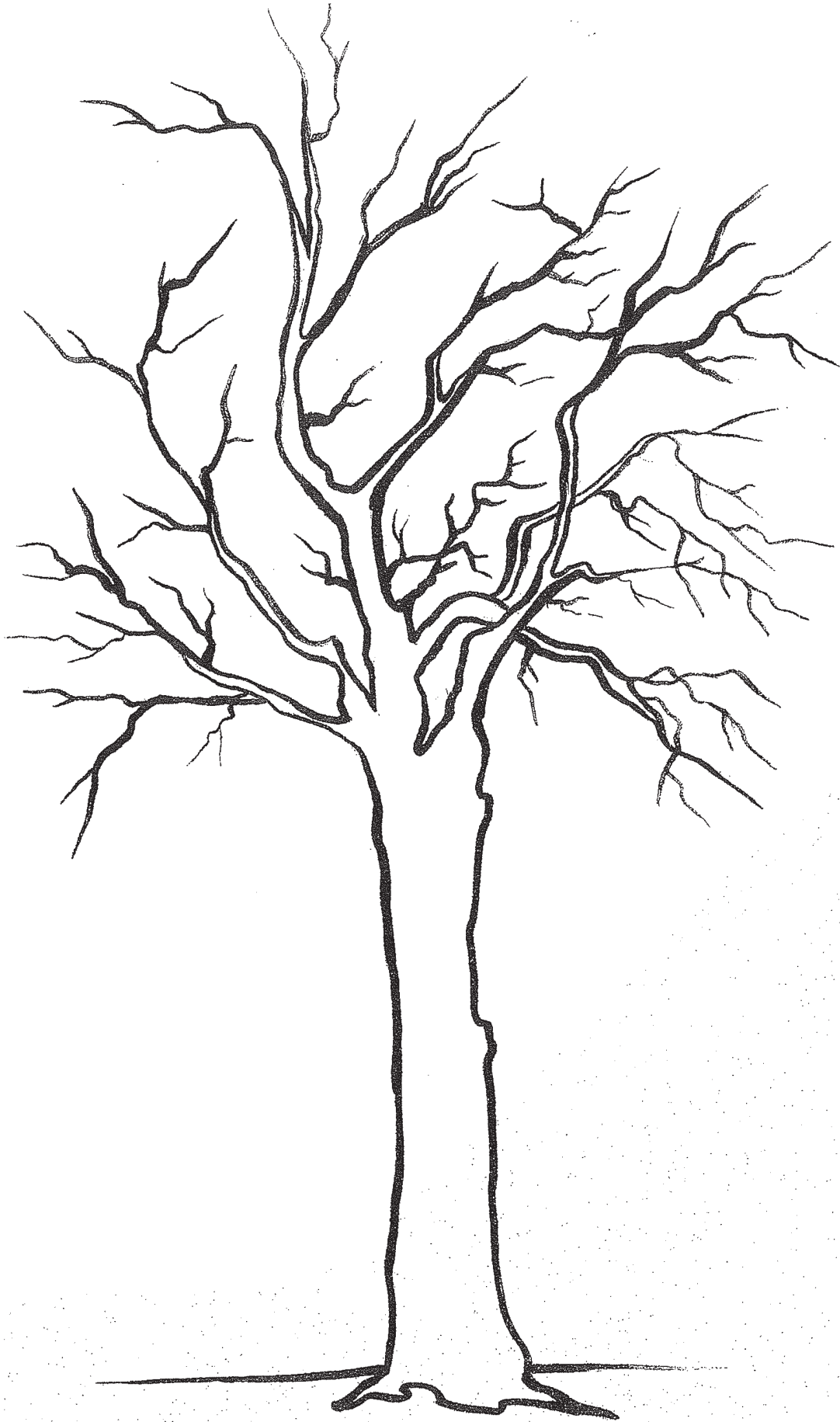

Rajzolj labdát!

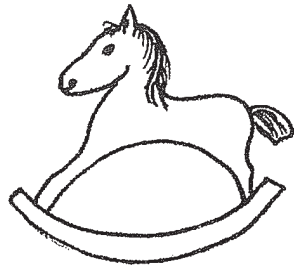

közé

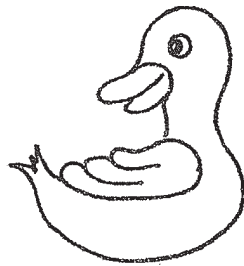

mellé

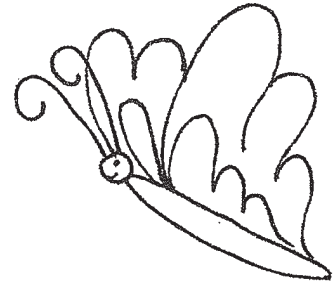

alá



föle

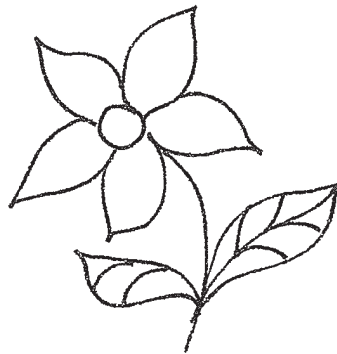

mellé

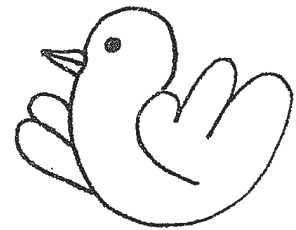

alá

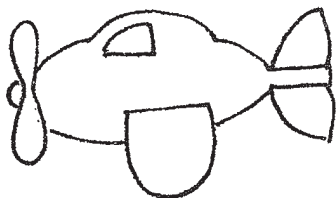

föle

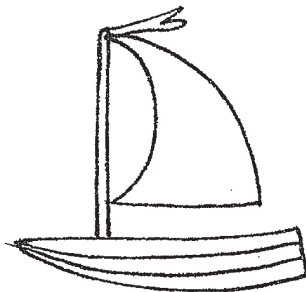

alá

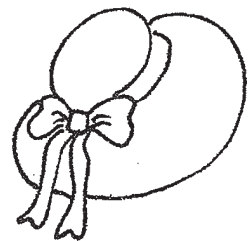

mellé

Rajzold meg a tükörképét!

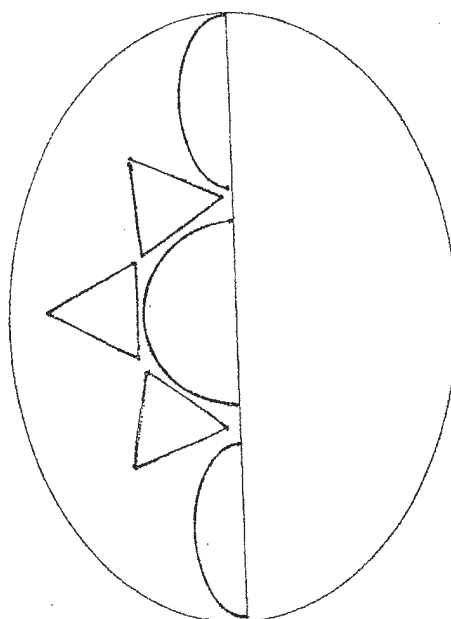
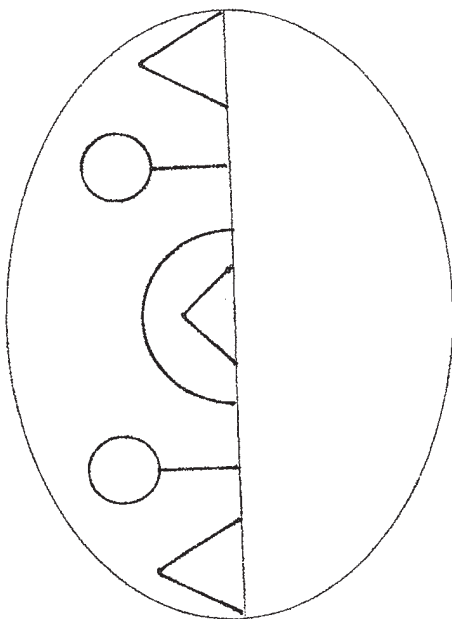
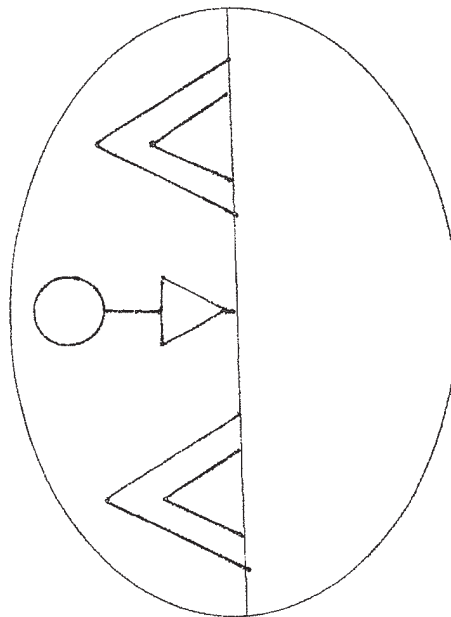
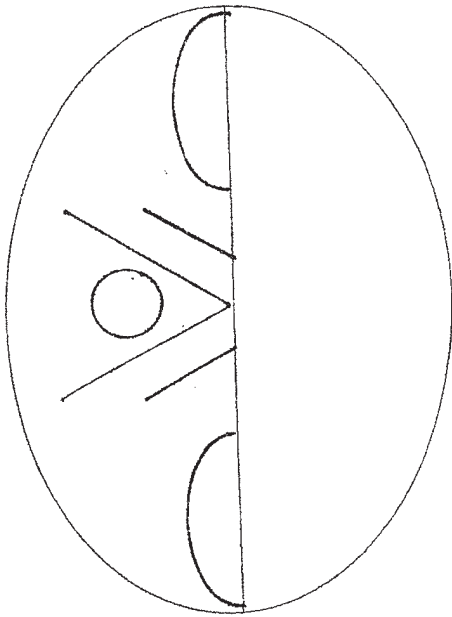

Fejezd be az oszlopmintát!

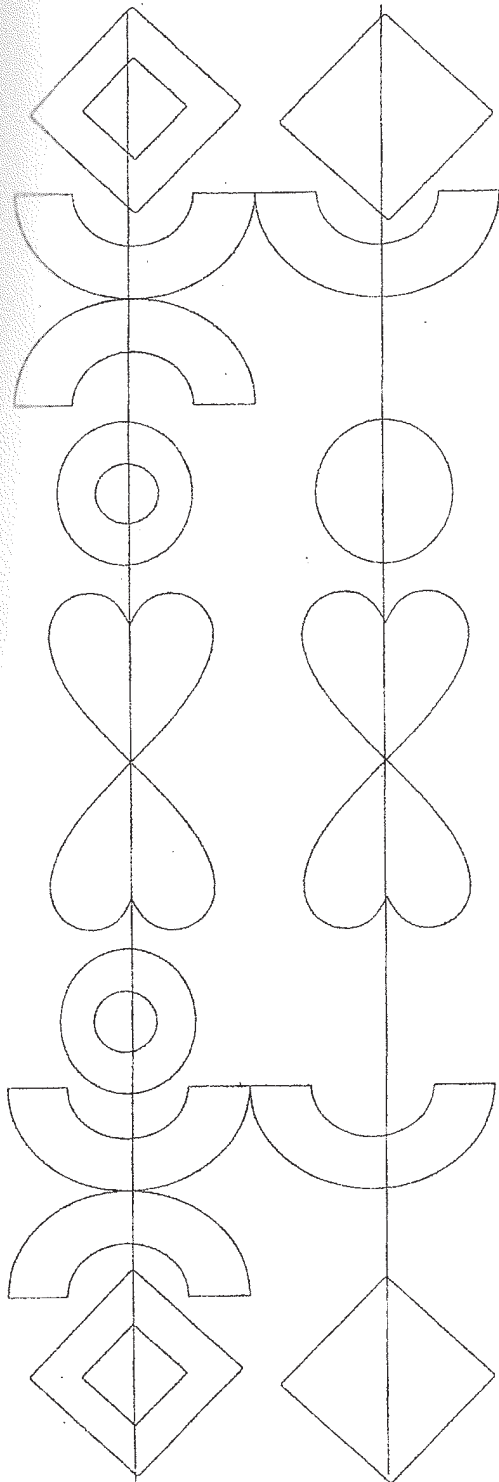

Rajzold meg a hiányzó füleket!

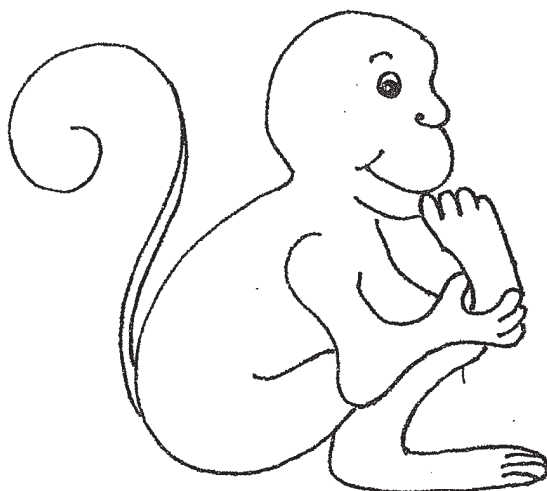
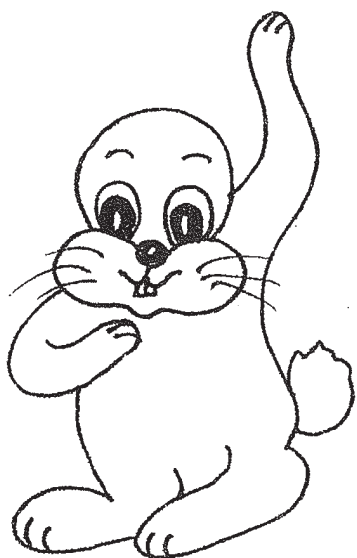
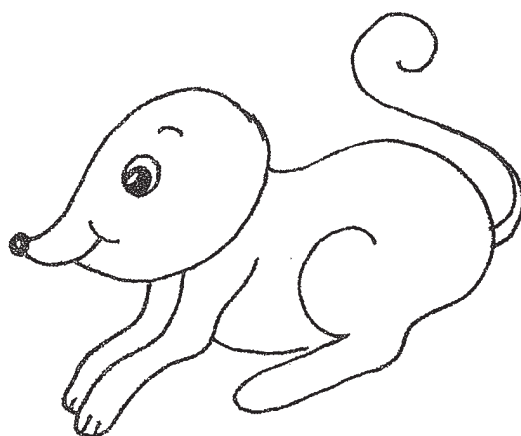
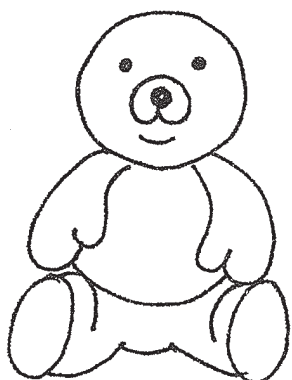
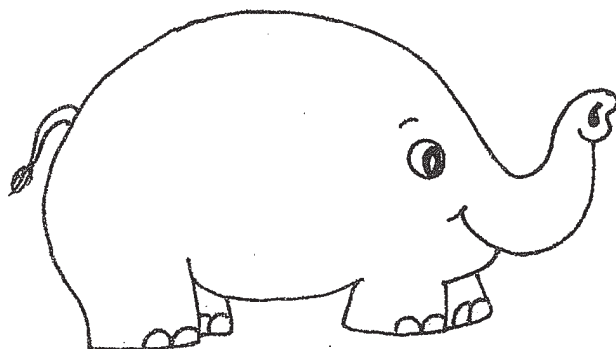
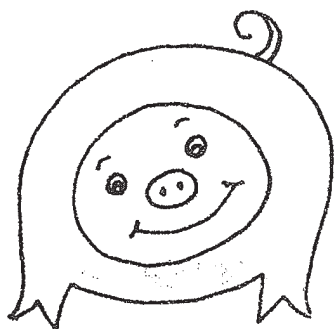



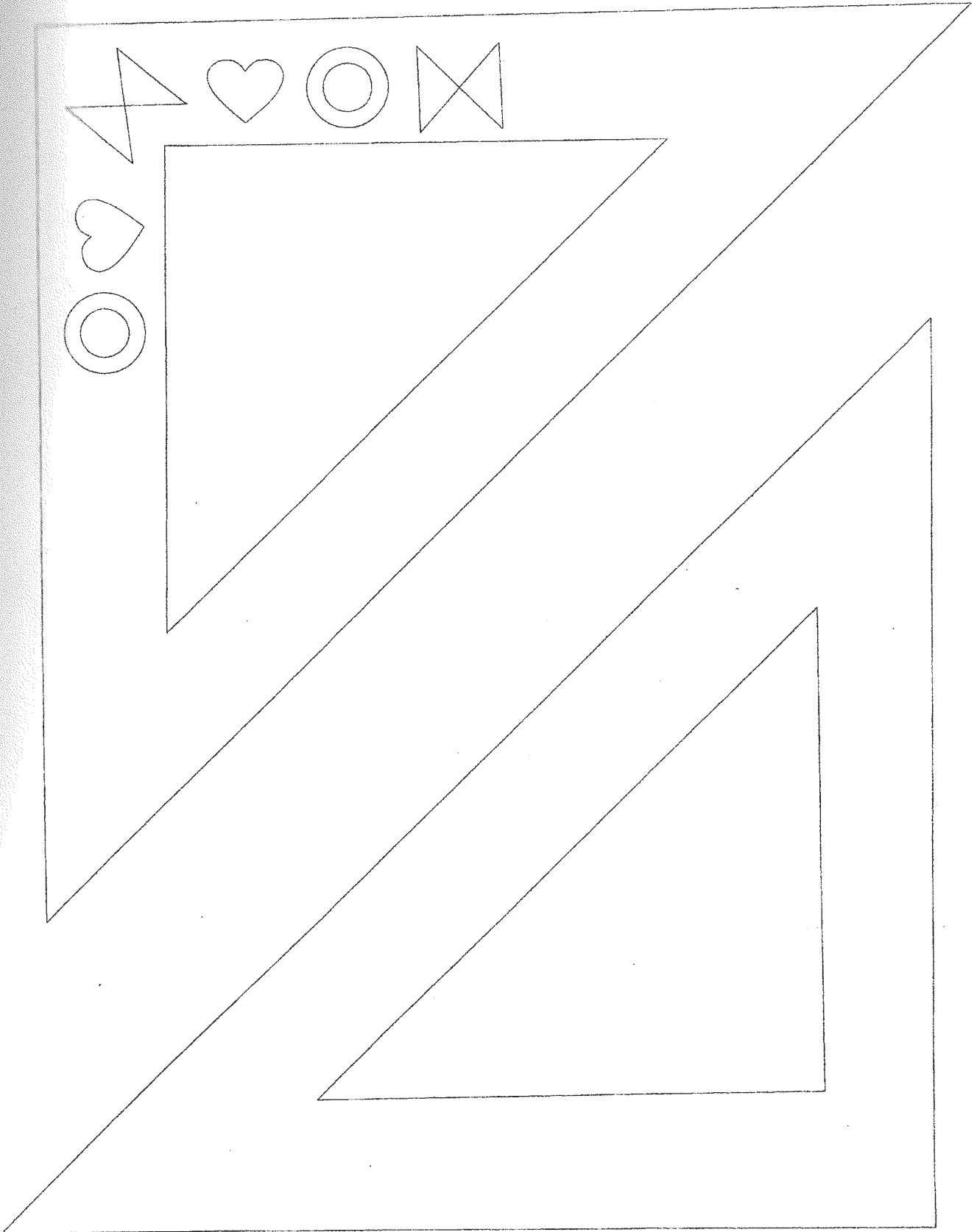

Díszítsd ki a kendőket!

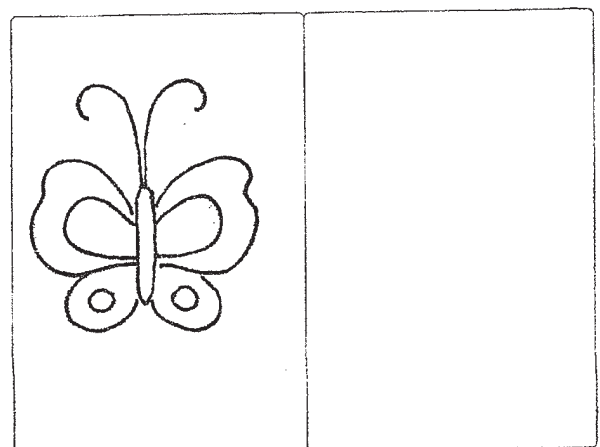
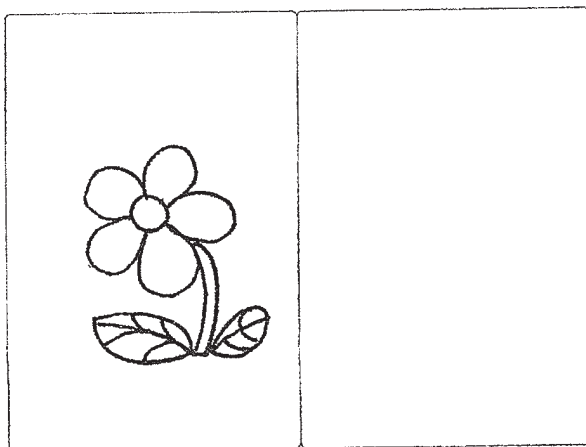
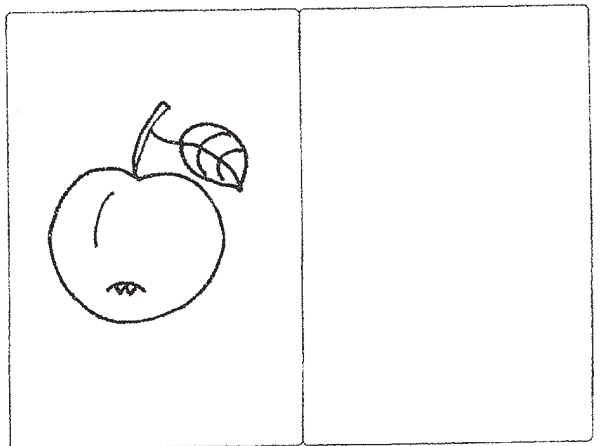
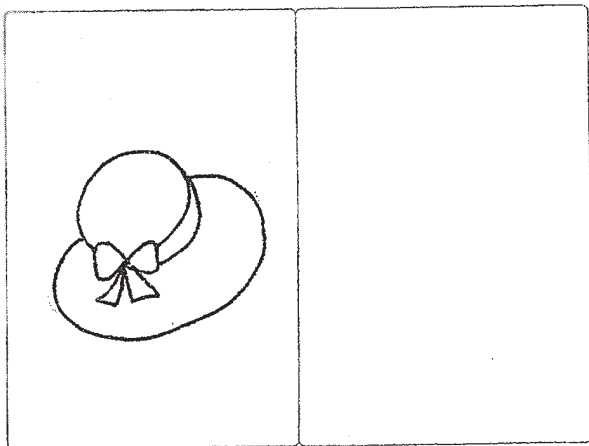
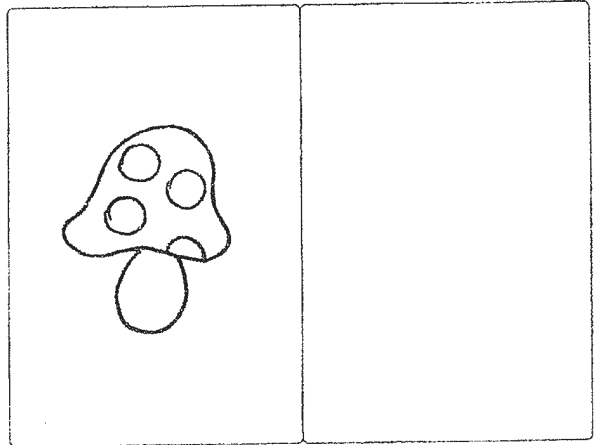
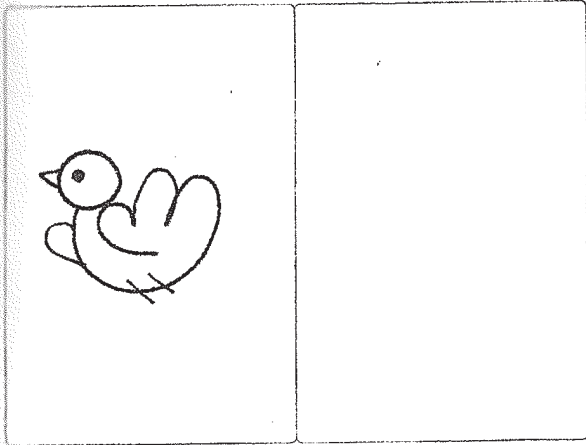

Másold át a rajzokat!



Színezd ki a robotot az utasítás szerint!

-  kék
-  sárga
-  piros
-  zöld

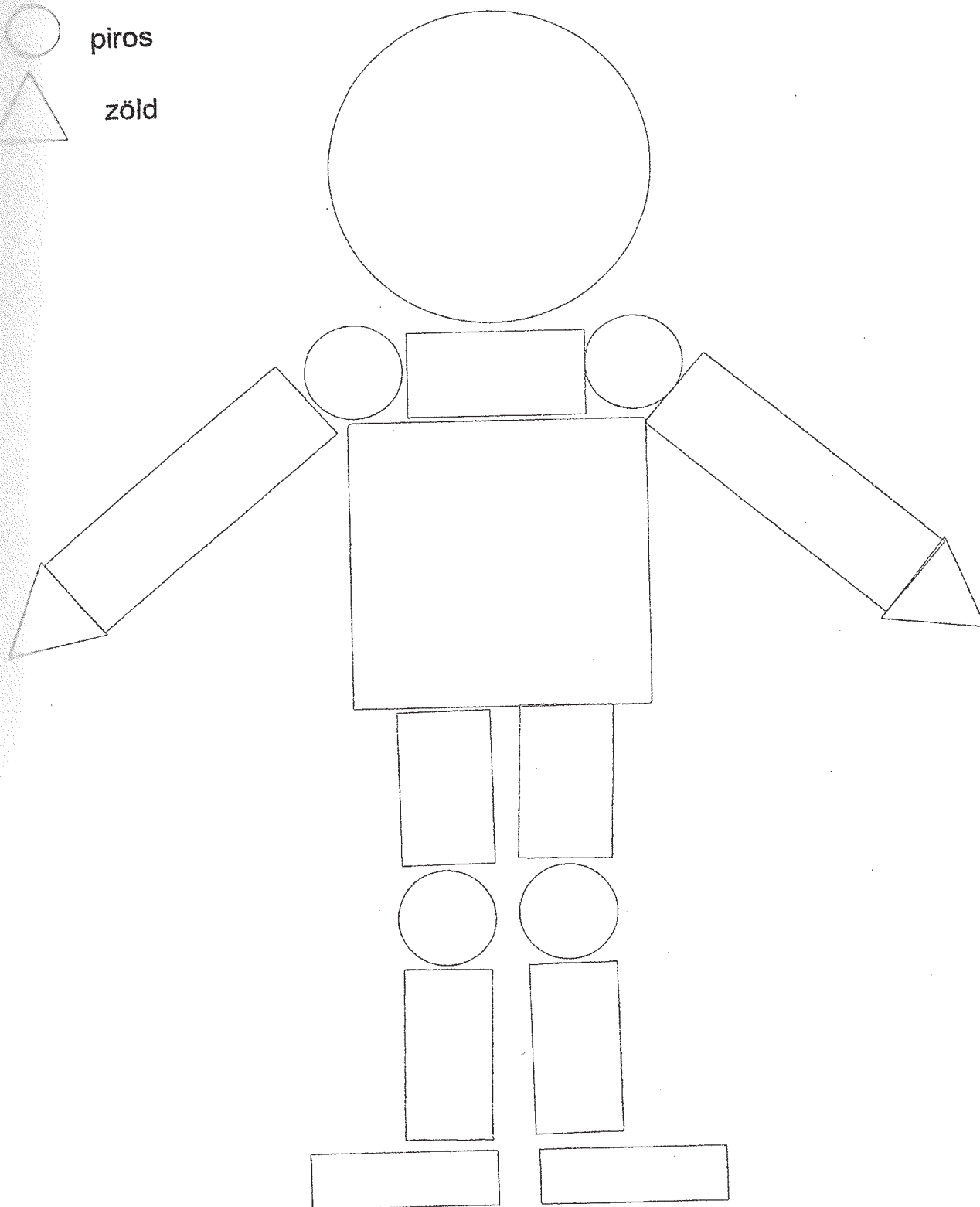

Rajzold be a tojások hiányzó mintáit!

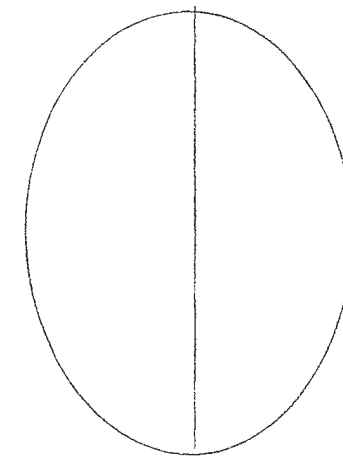
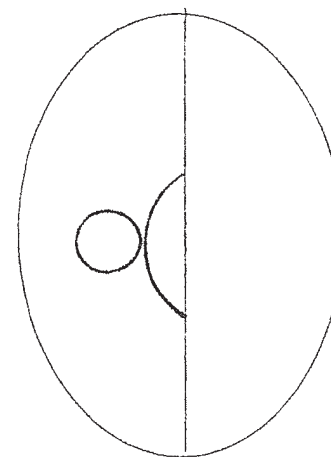
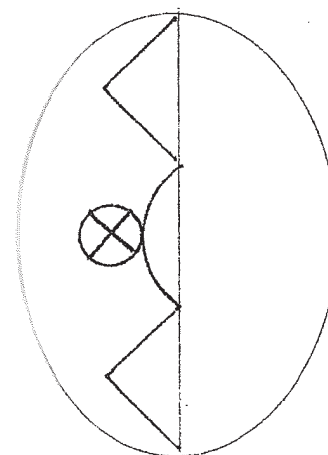
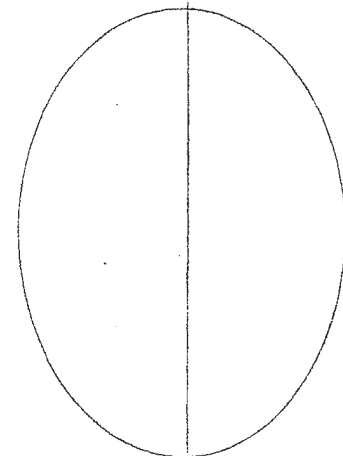
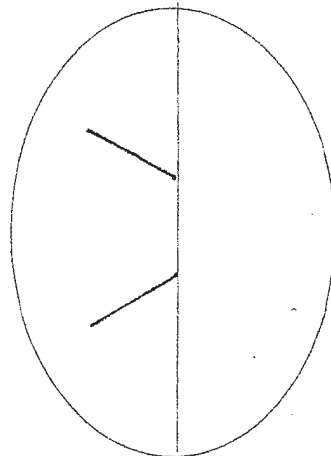
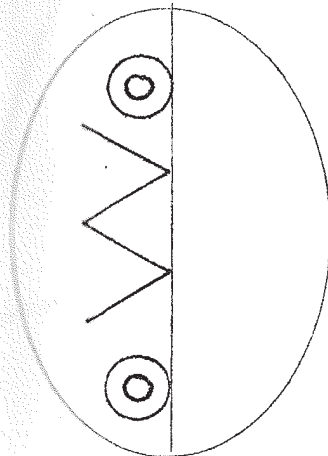
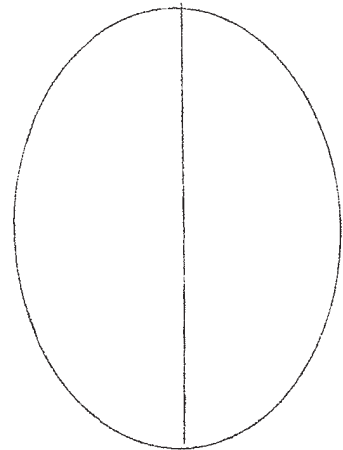
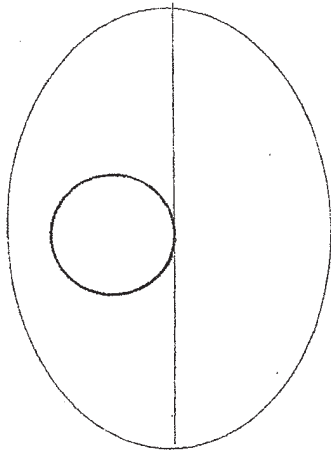
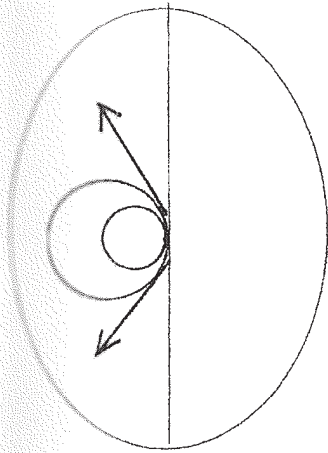

Díszítsd ki az esernyőt!



Másold át a csigavonalat kívülről befelé, majd belülről kifelé!

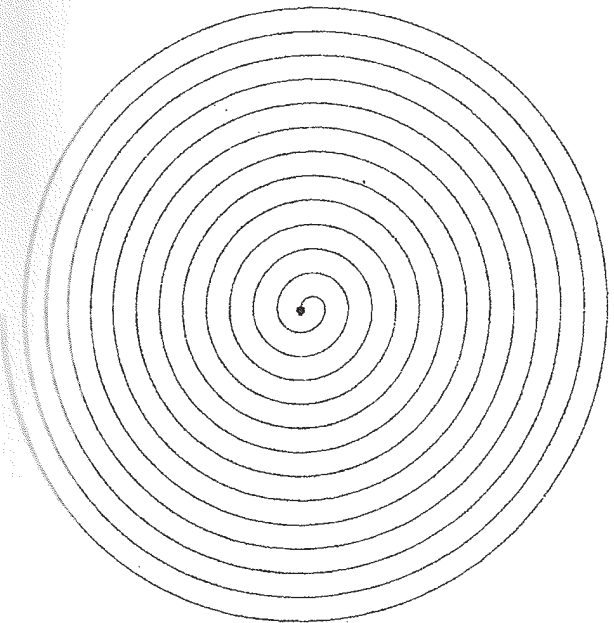
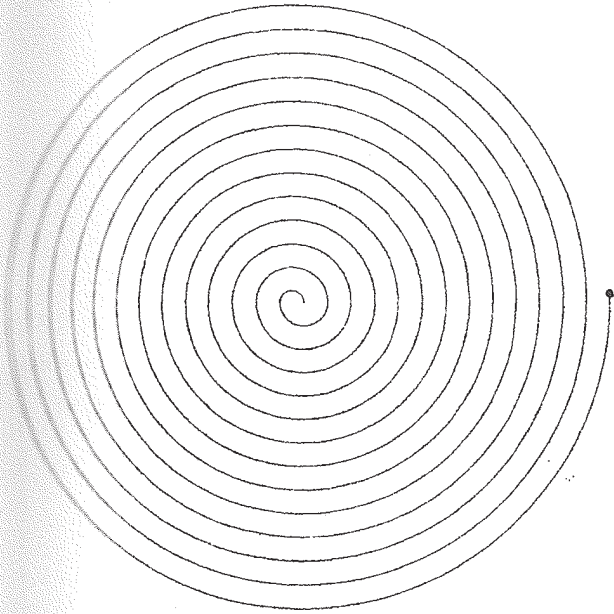

Rajzold be a négy rajzot egyenként a négyzetekbe úgy, hogy sem az oszlopokban, sem a sorokban ne legyen ismétlődés!



Másold át a rajzokat!

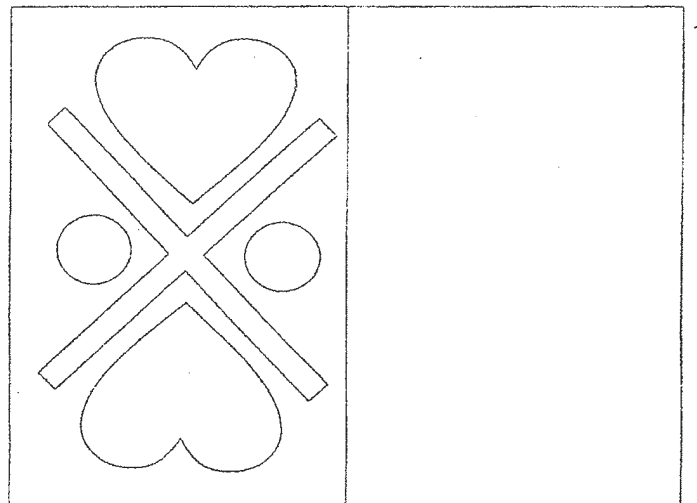
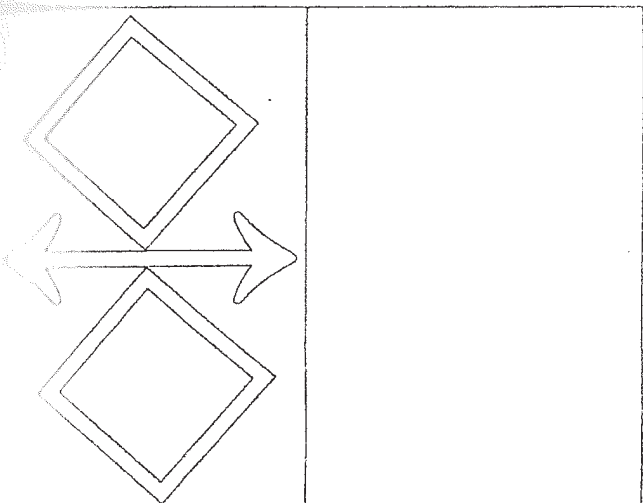
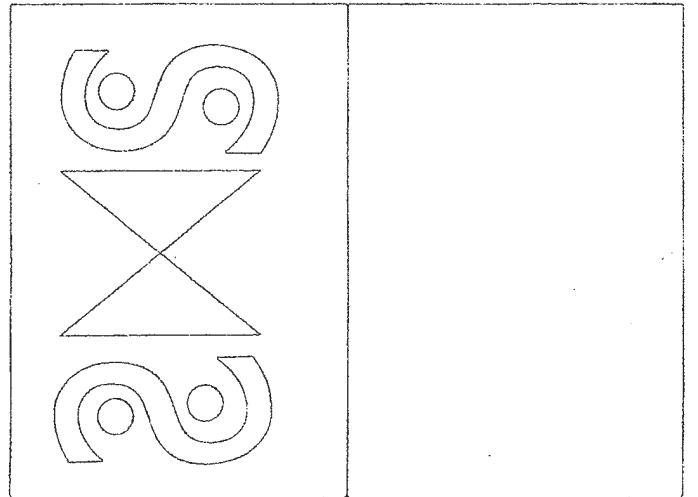
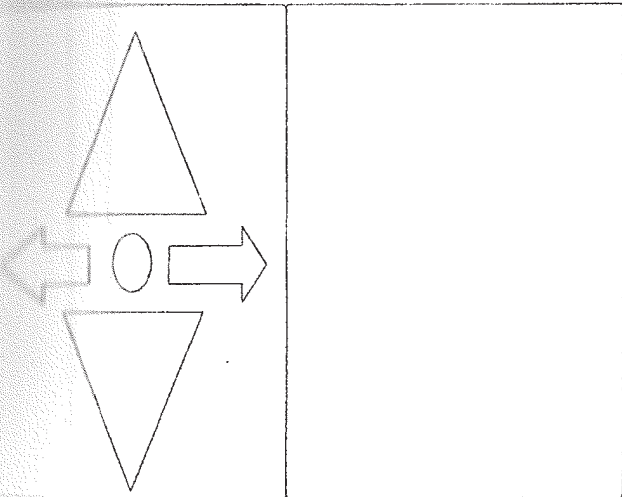
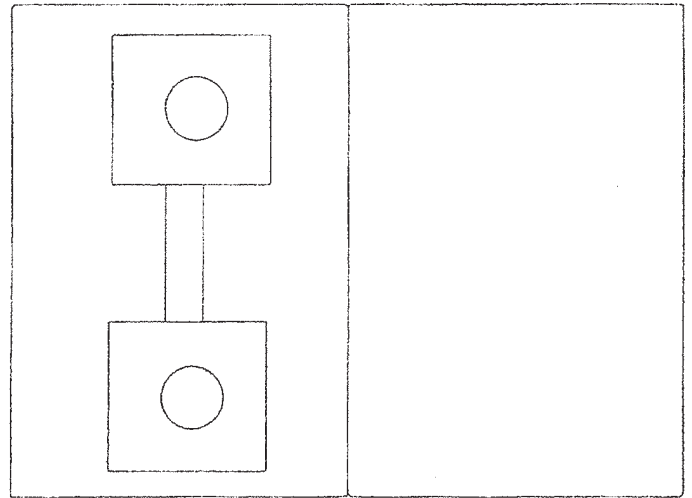
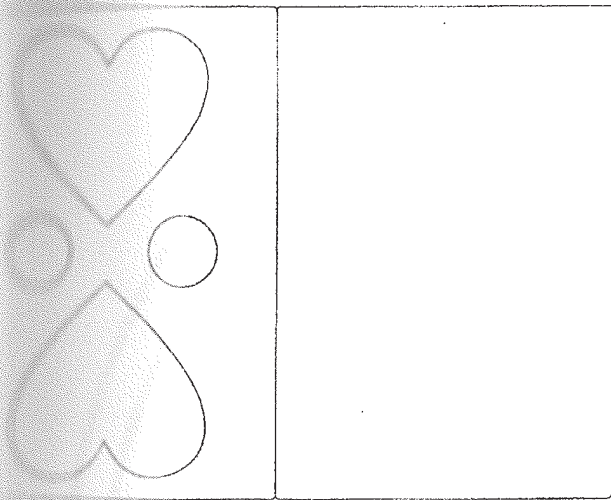

Nézz ki az ablakon, és rajzold le a tájat!

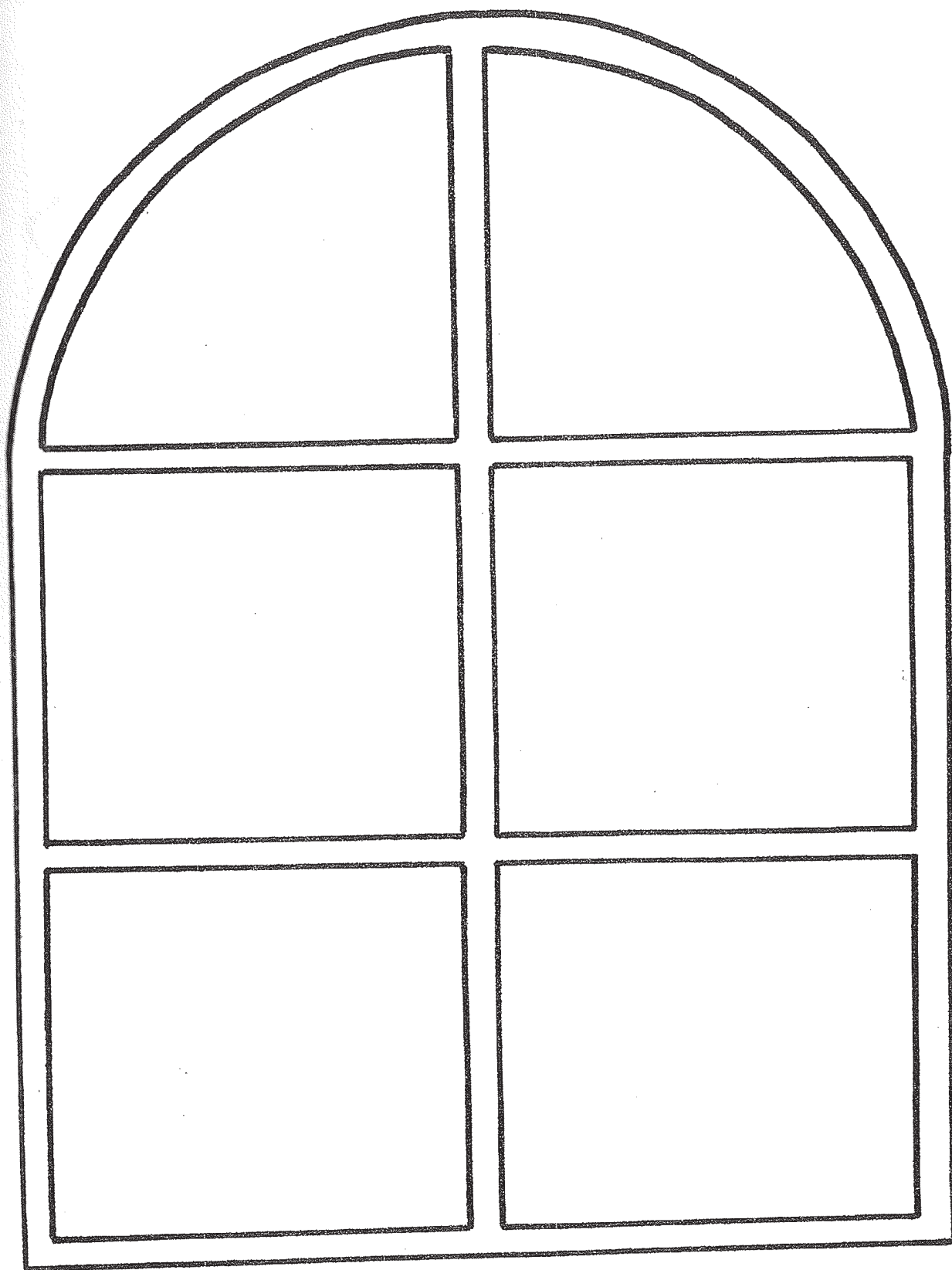

Vágd ki a testrészeket, és a másik oldalon ragaszd a megfelelő helyre!

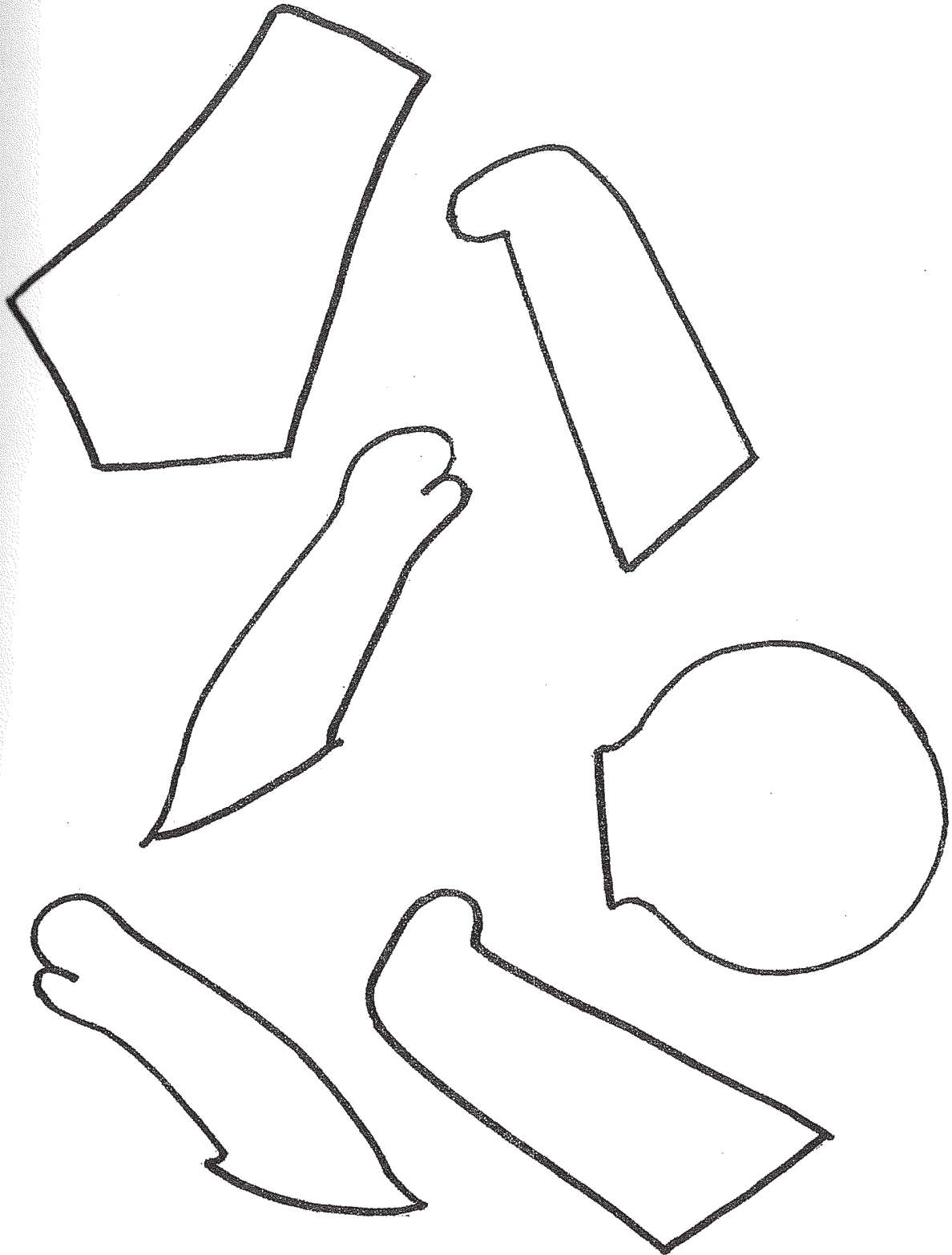

Ezután színezd ki!

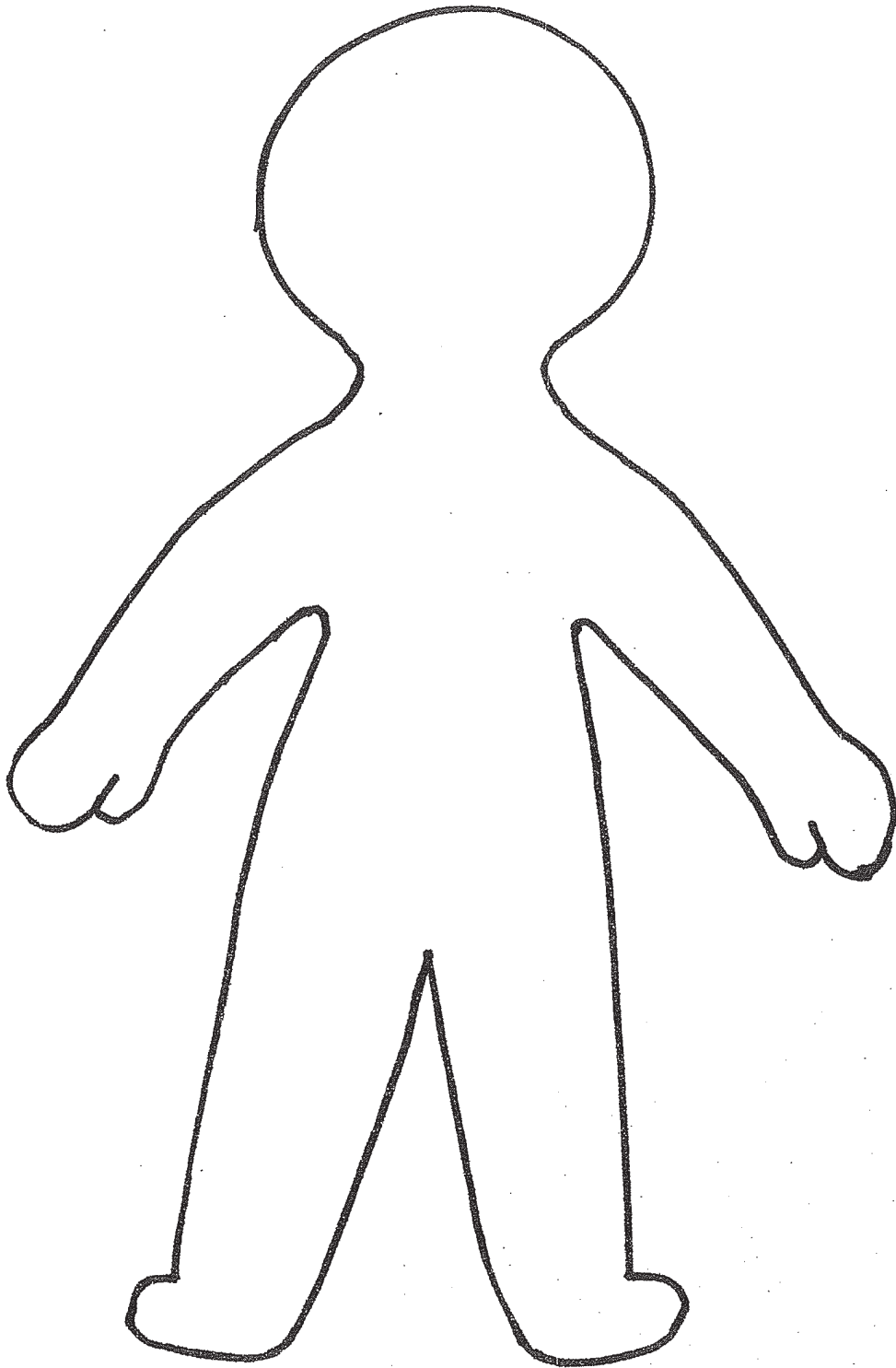

Rajzold be az öt rajzot egyenként a négyzetekbe úgy, hogy sem az oszlopokban, sem a sorokban ne legyen ismétlődés!

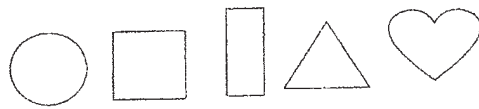

Rajzold meg az elefánt tükörképét!

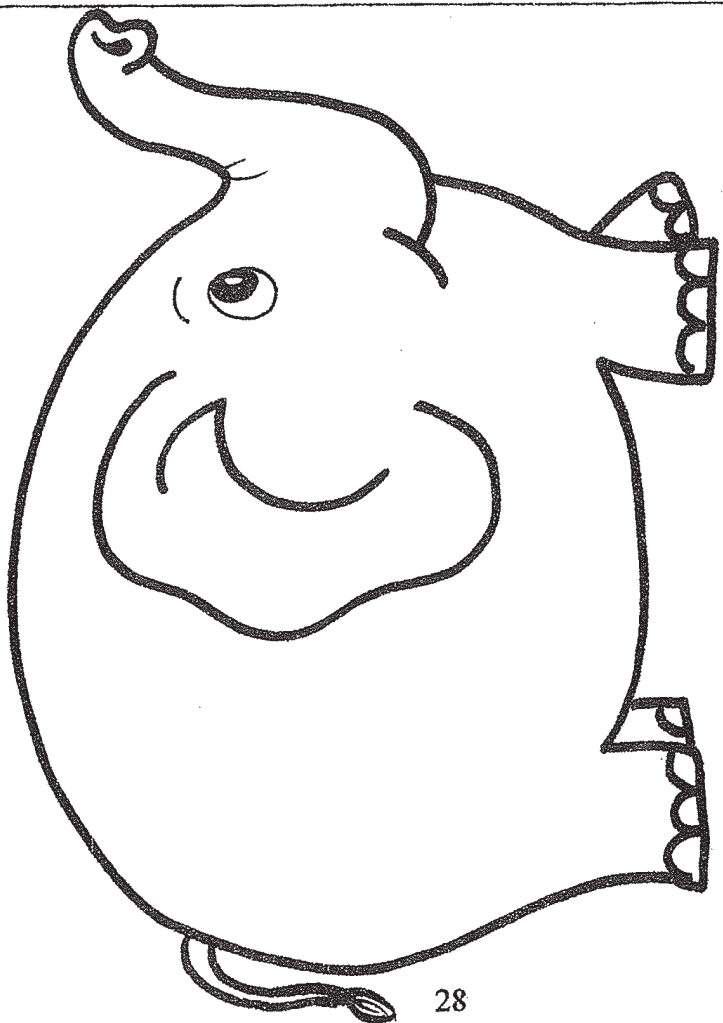

Rajzolj kisebb házakat kevesebb ablakkal!

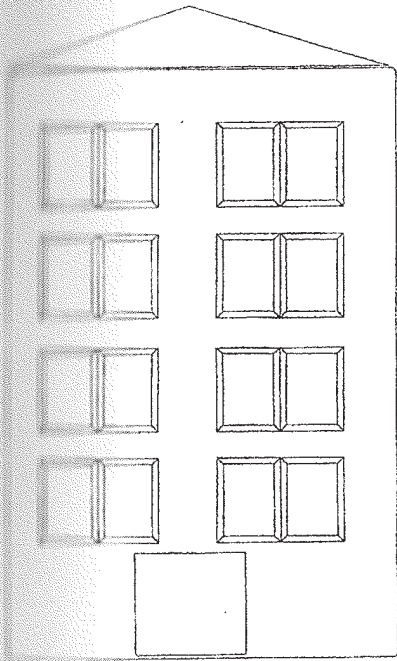

Rajzolj nagyobb házakat több ablakkal!

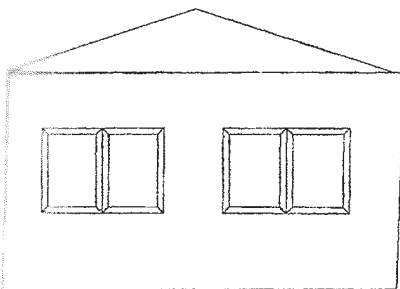

Színezd ki a számokat!

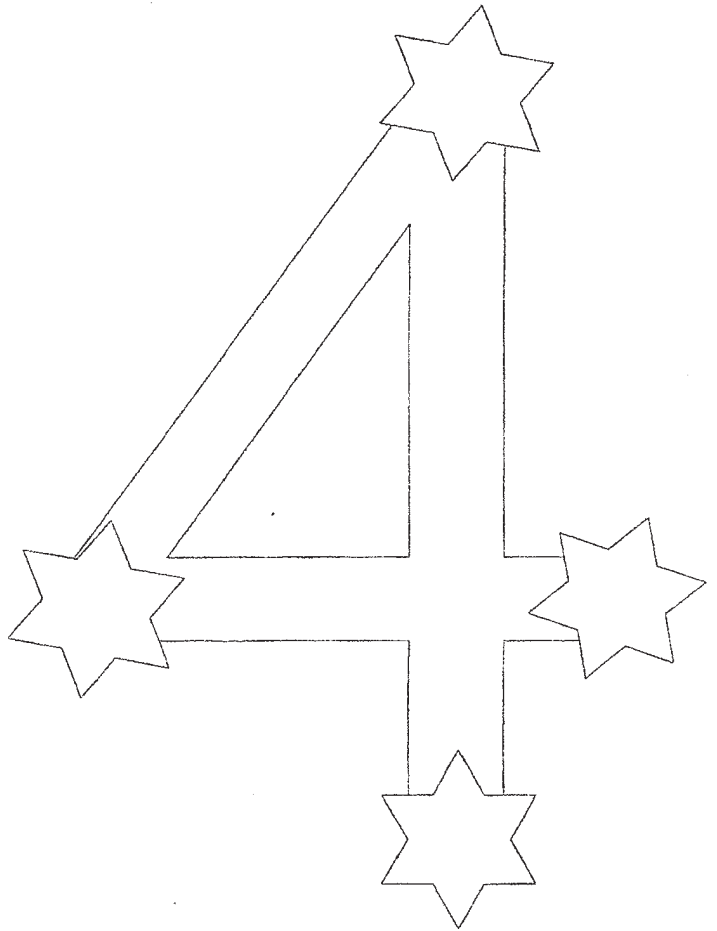
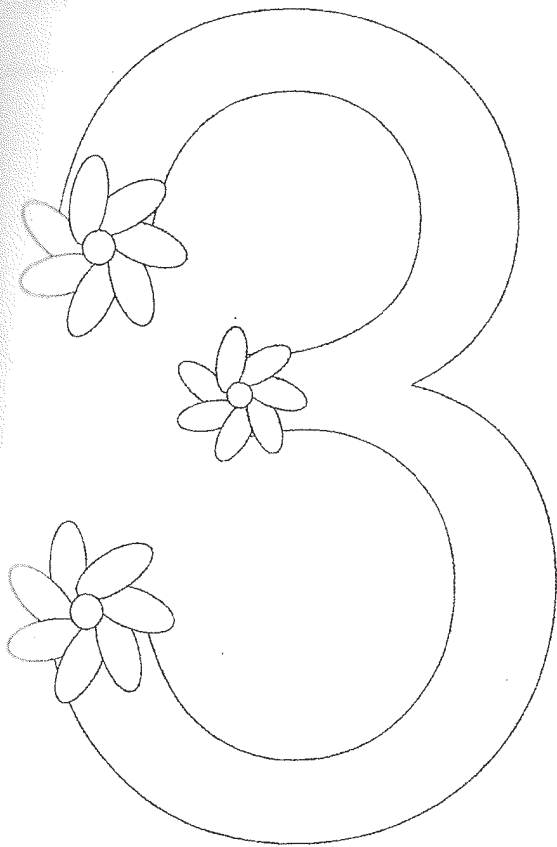
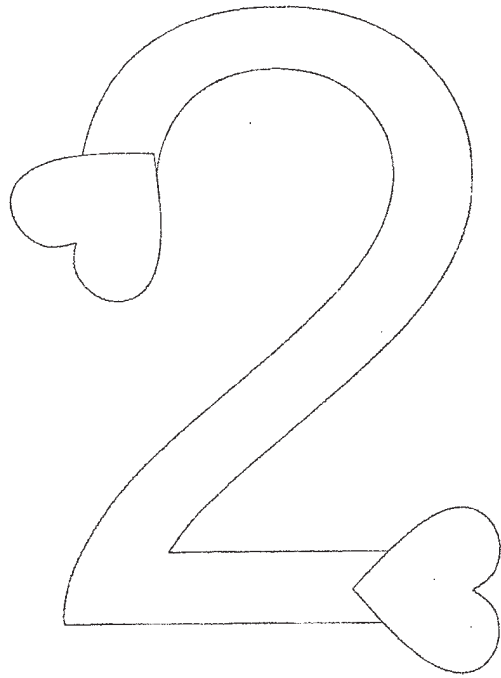
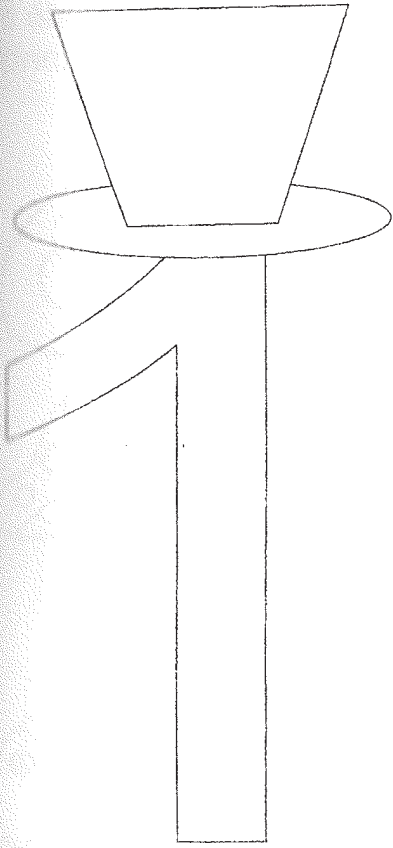

Mit ábrázolnak a rajzok? Sorold fel a nevüket! Hol helyezkednek el?
Színezd ki őket!

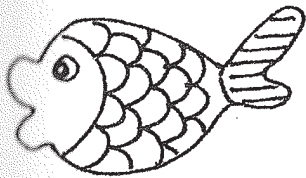
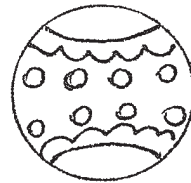
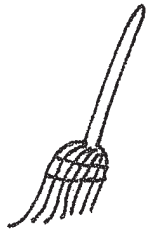
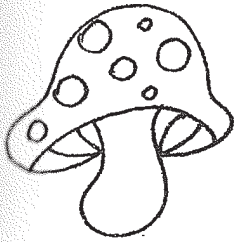
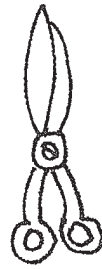
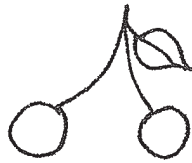
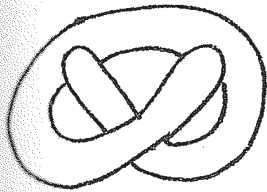

Másold le a rajzokat a helyzetüknek megfelelő négyzetekbe!

Önts (vagyis rajzolj) vizet a poharakba!

félig

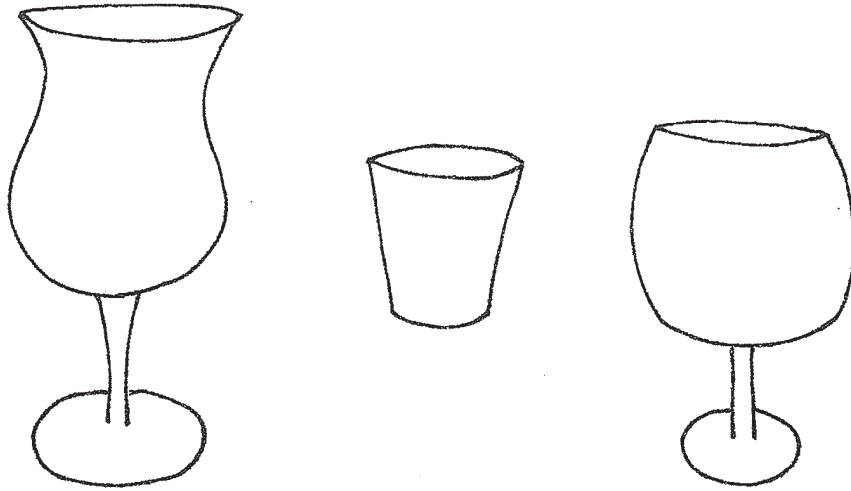

teli

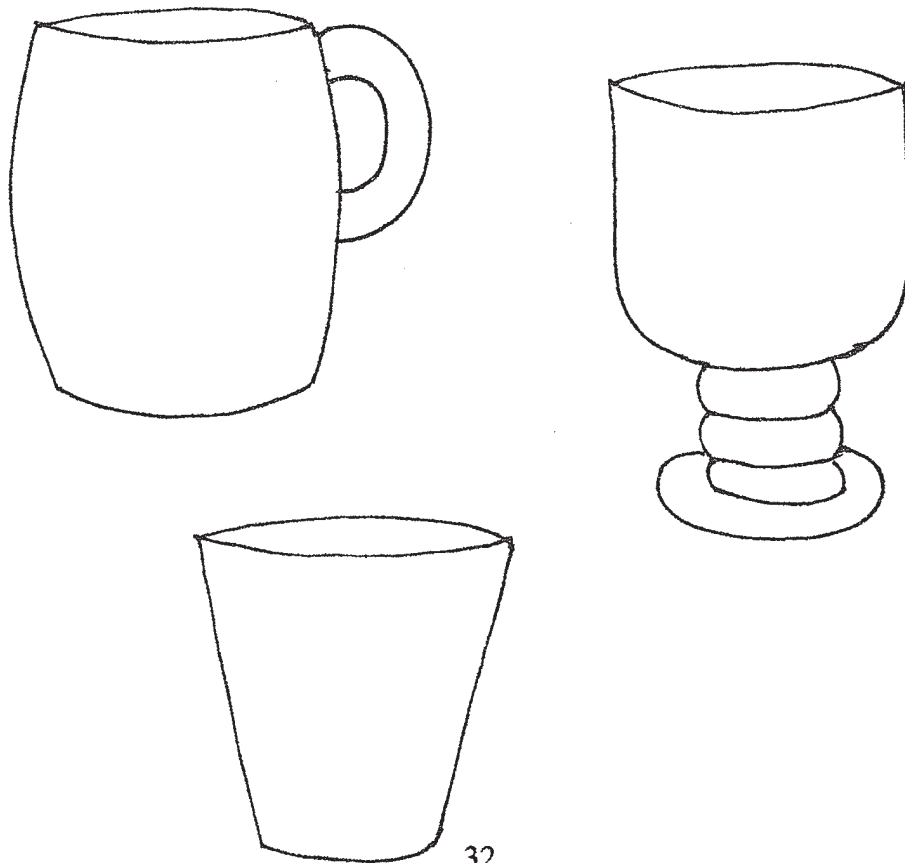

Rajzold le a tükörképét!

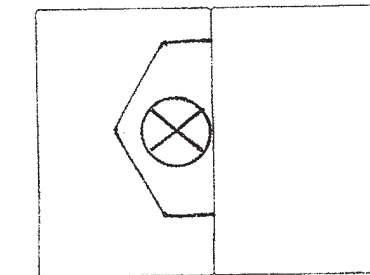
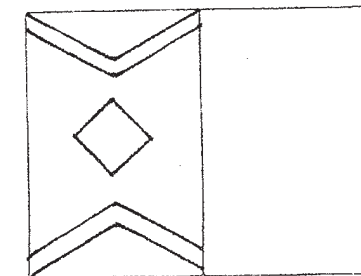
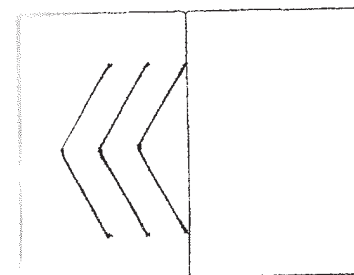
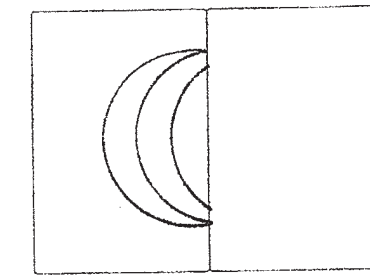
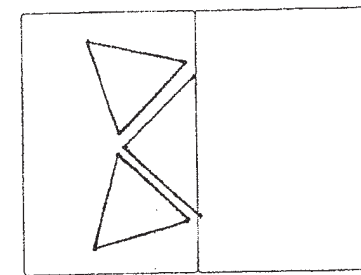
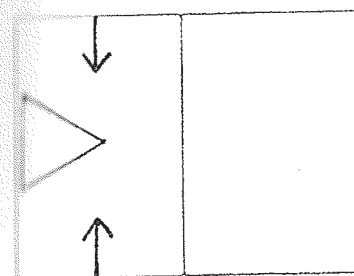
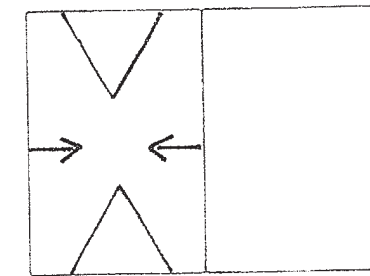
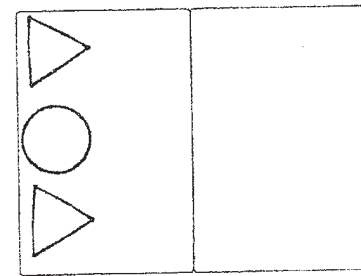
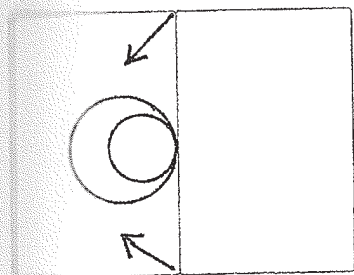
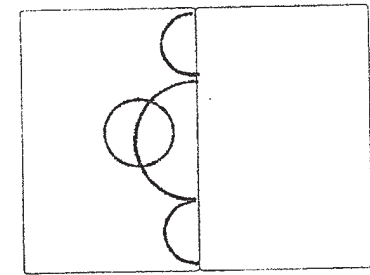
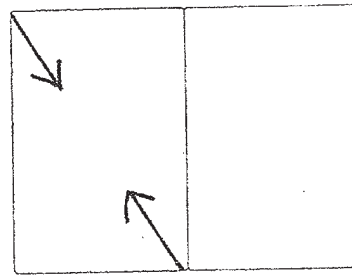
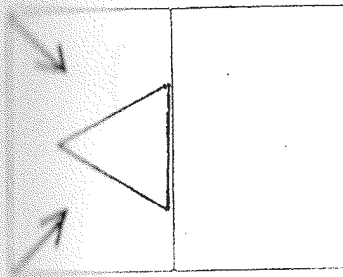
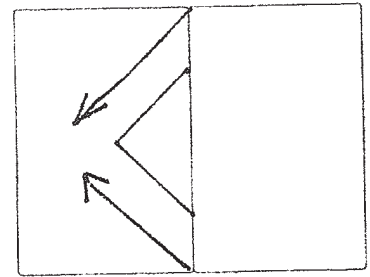
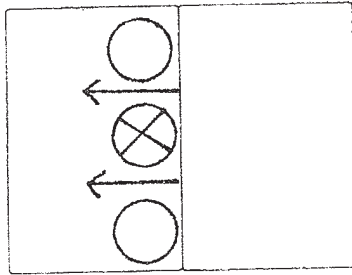
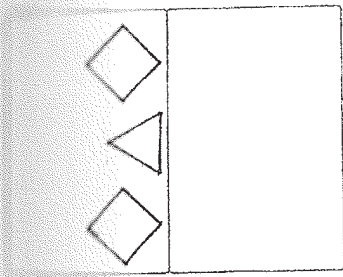

Mi a közös a képekben?

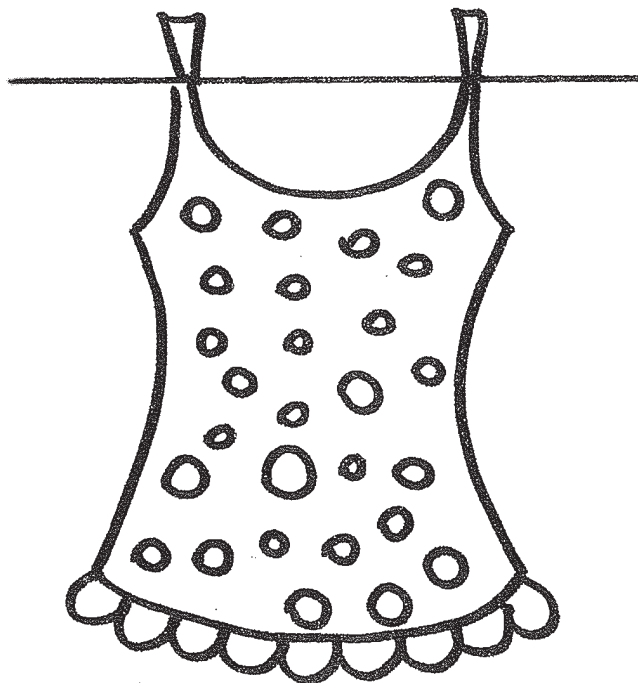
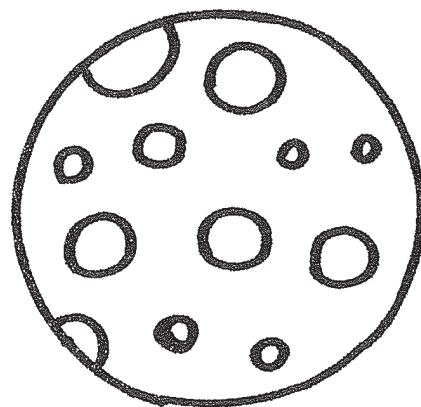
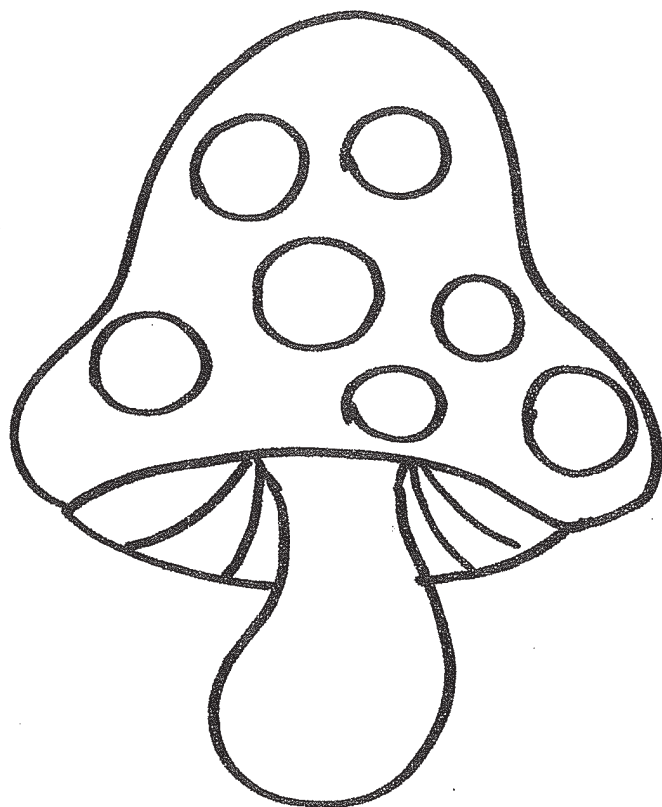

#rajzold kockás mintát a ruhadarabokra!

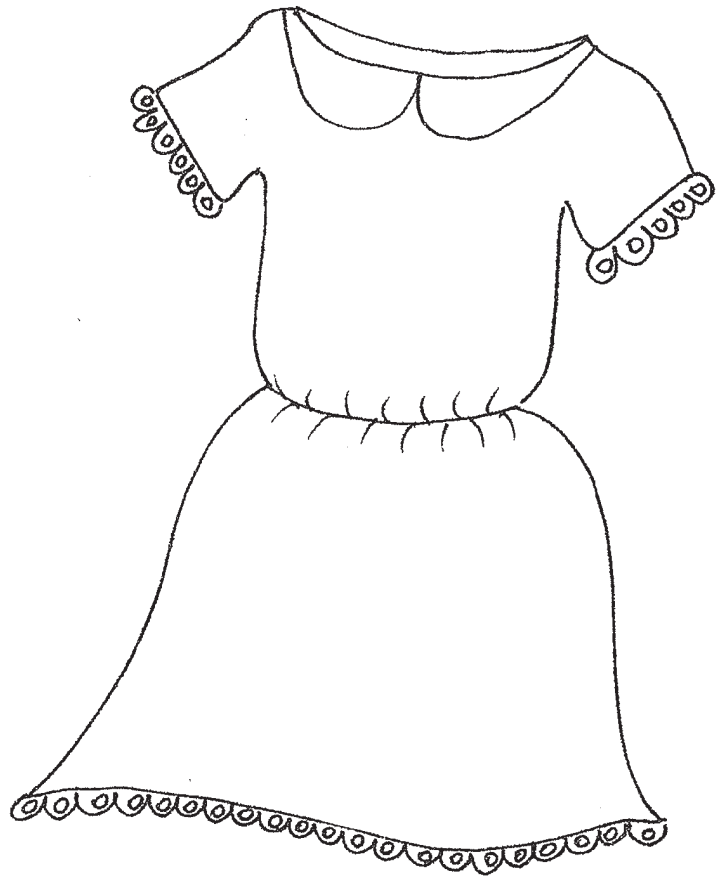
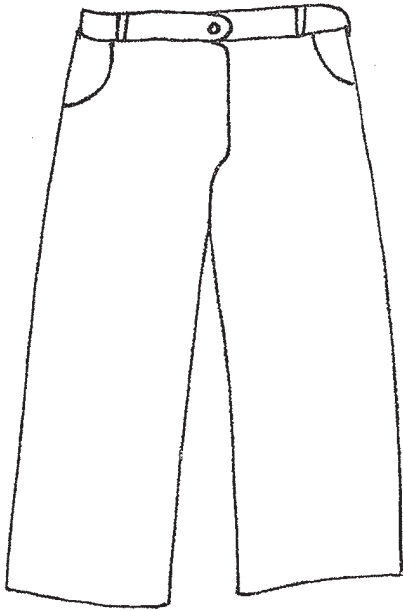
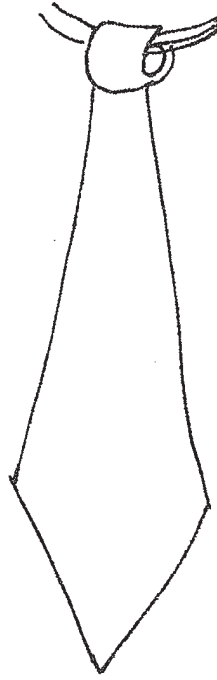

Kösd össze az azonos ábrákat!
Színezd egyformára az egymáshoz tartozókat!

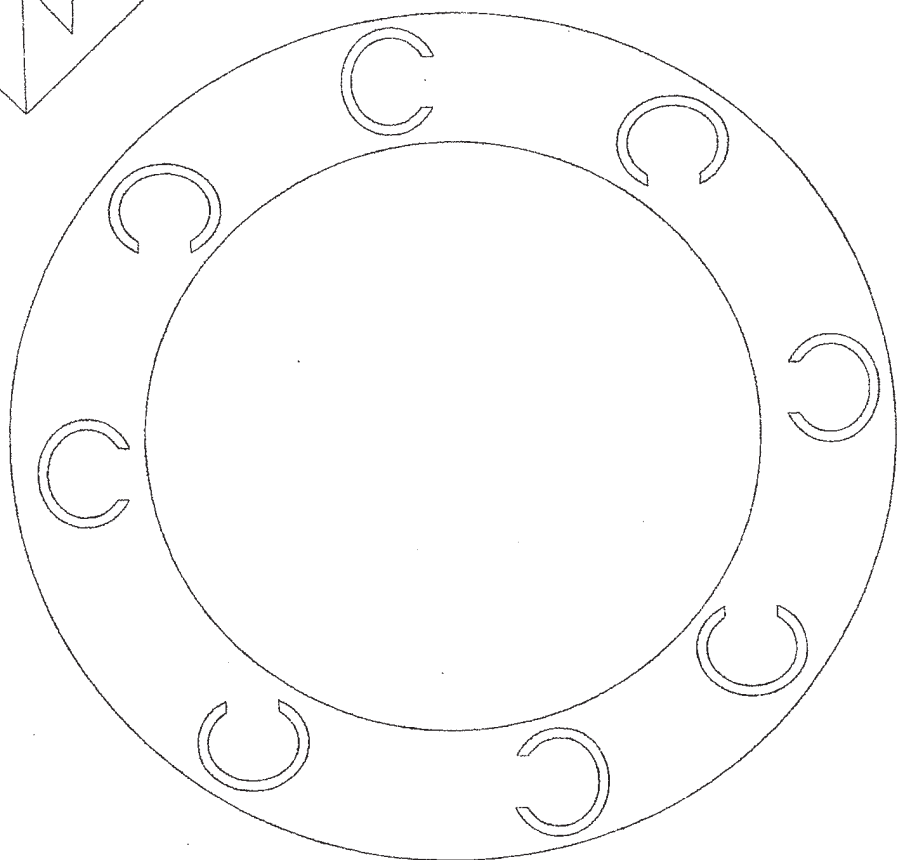
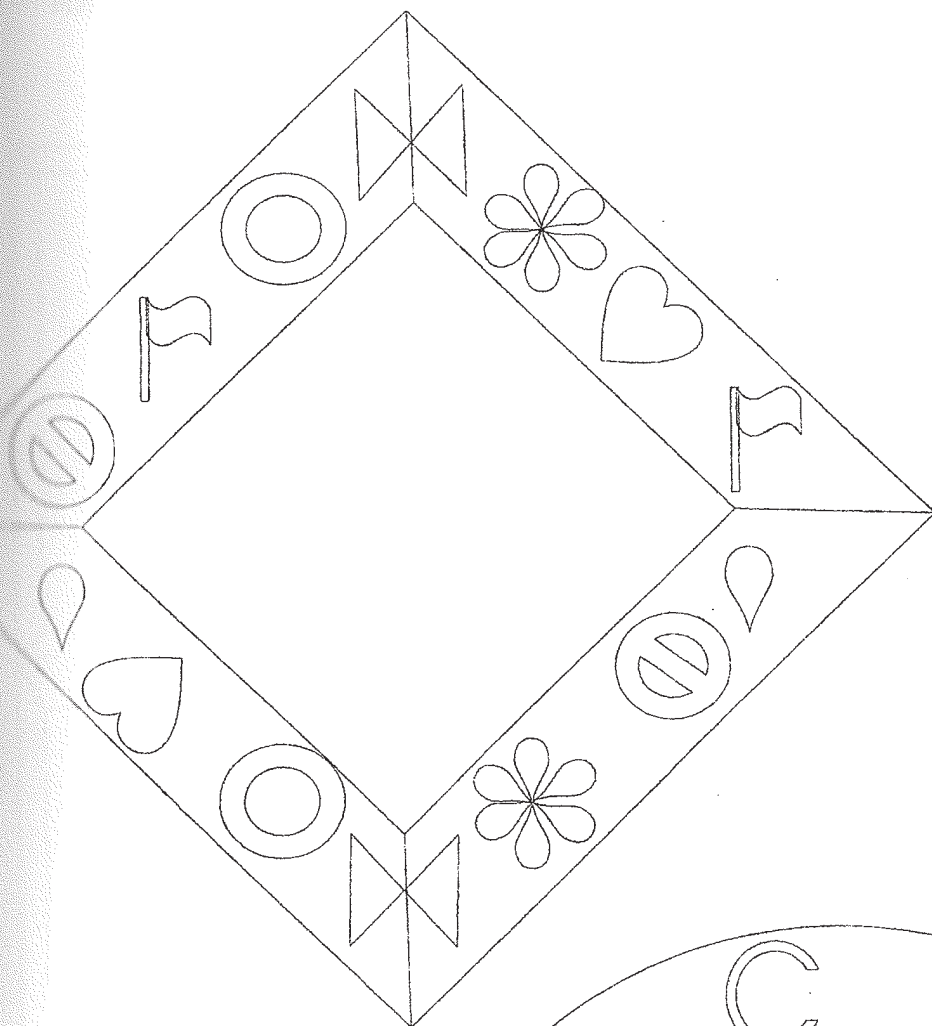

Rajzolj jégvirágokat az ablaküvegre!

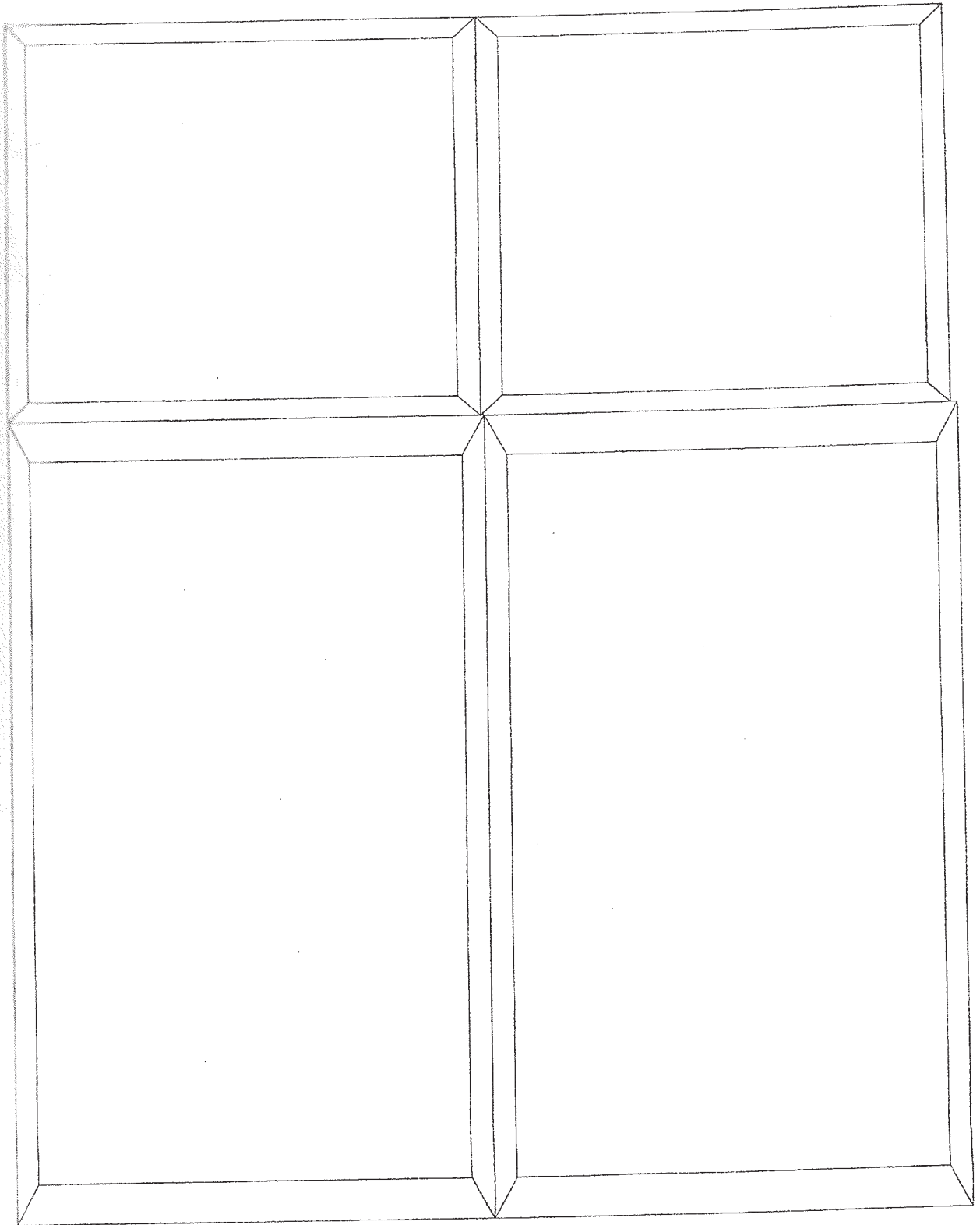

Kösd össze az azonos ábrákat!

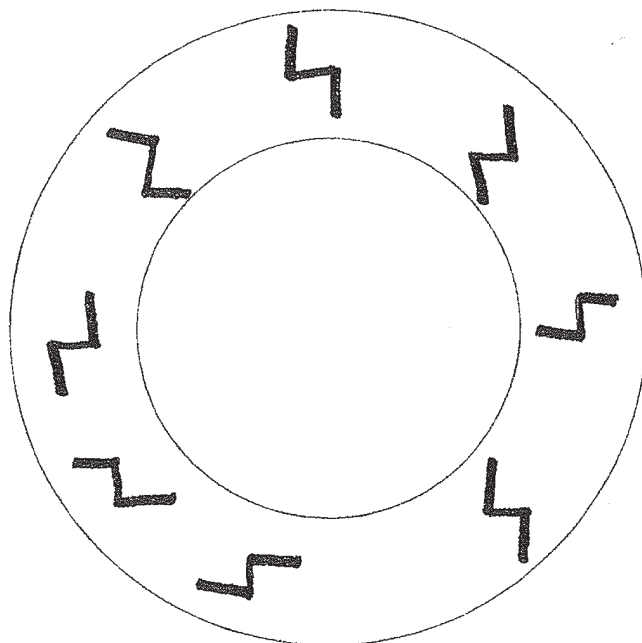
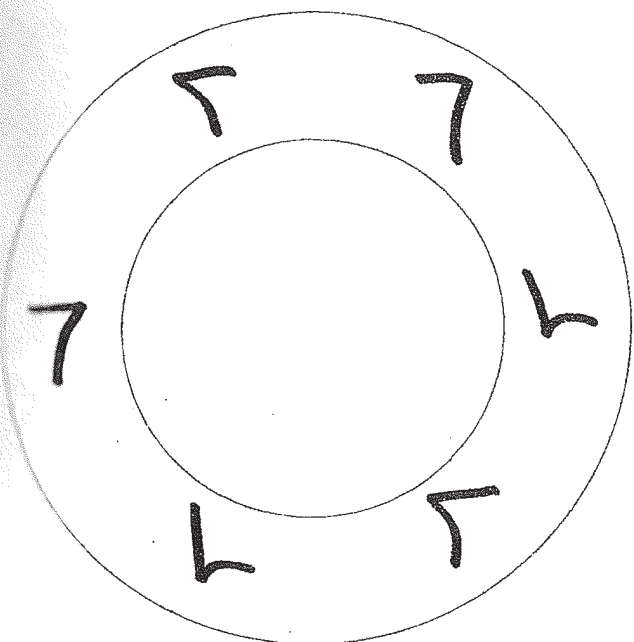
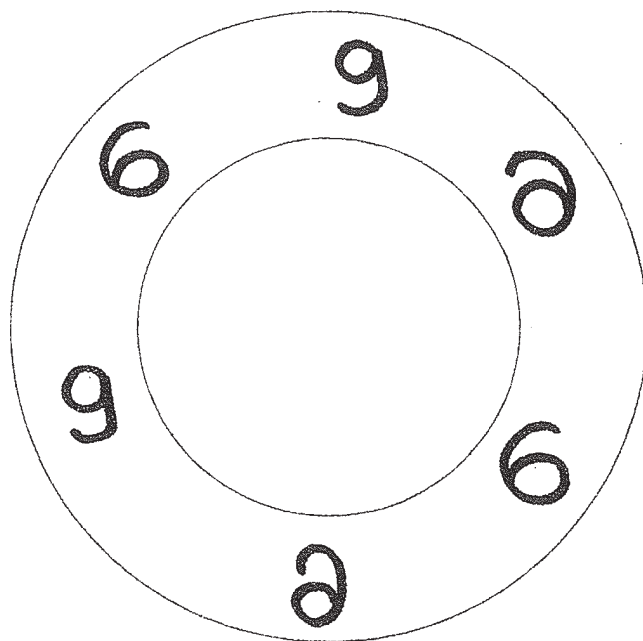
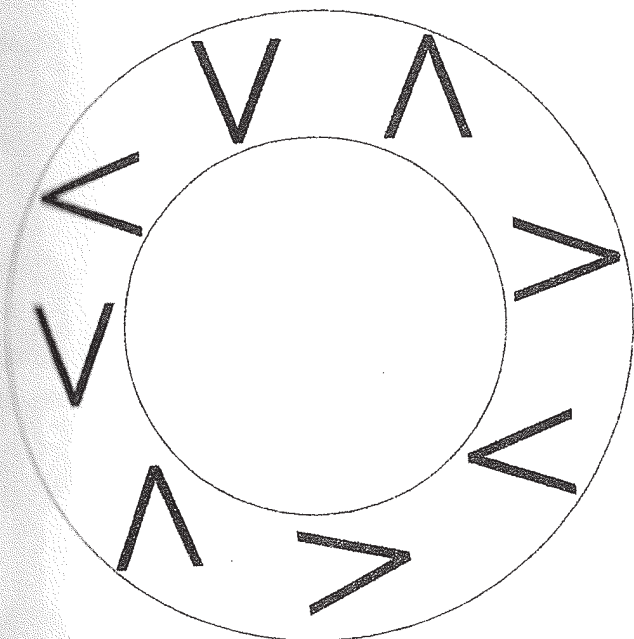

Rajzold le a tükörképed!

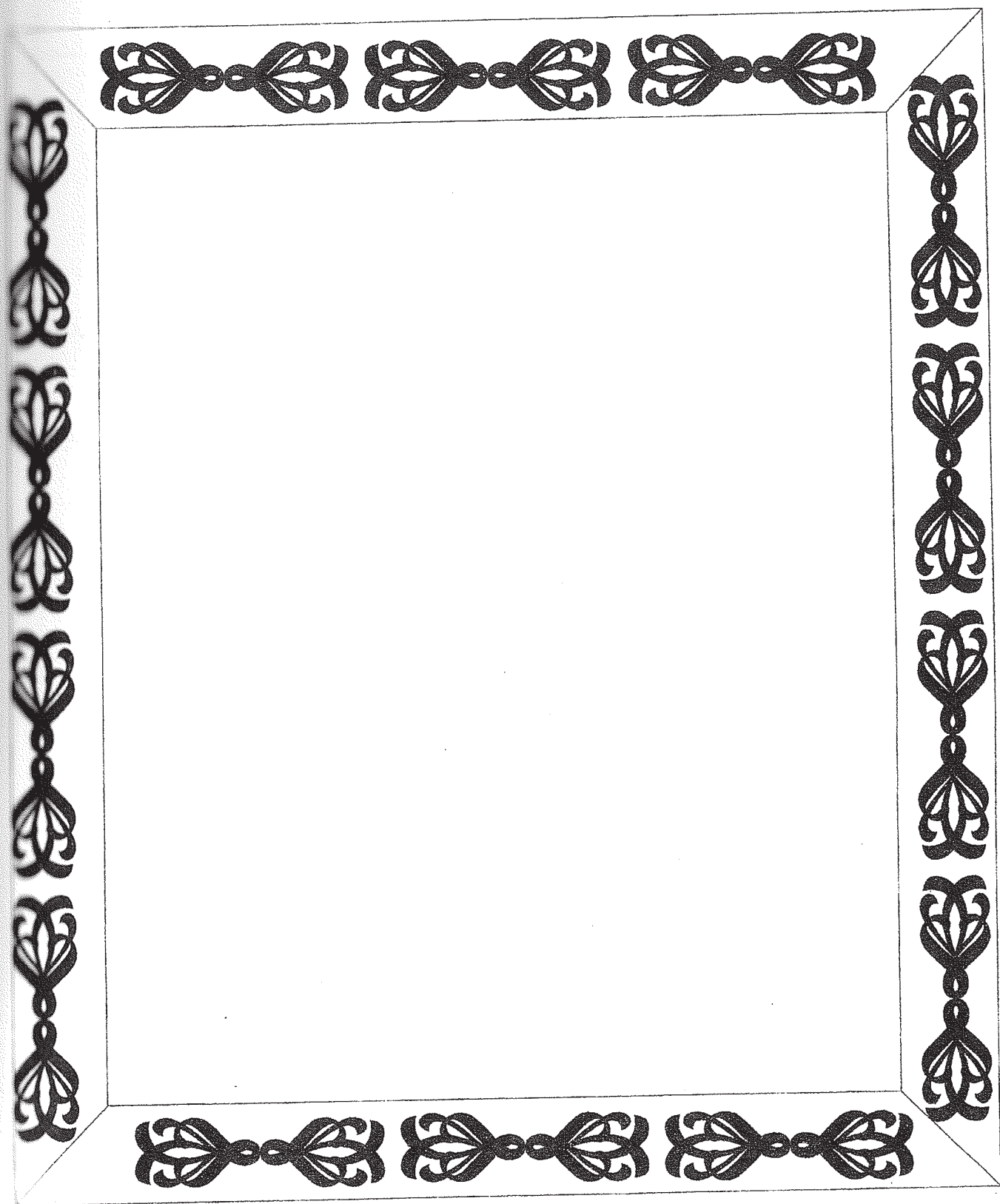

Rajzold le a

lapát nyelét



csavar menetét



torta díszét

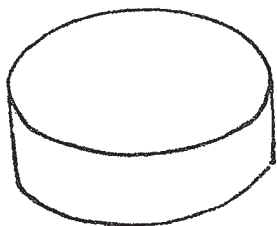

virág szirmait



hal pikkelyeit

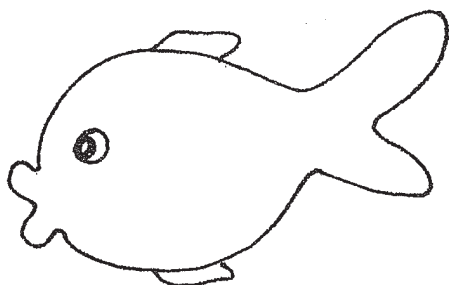

dinnye magjait



Jól figyeld meg az ábrákat!
Azután csukd össze a könyvet, és sorold fel őket emlékezetből!

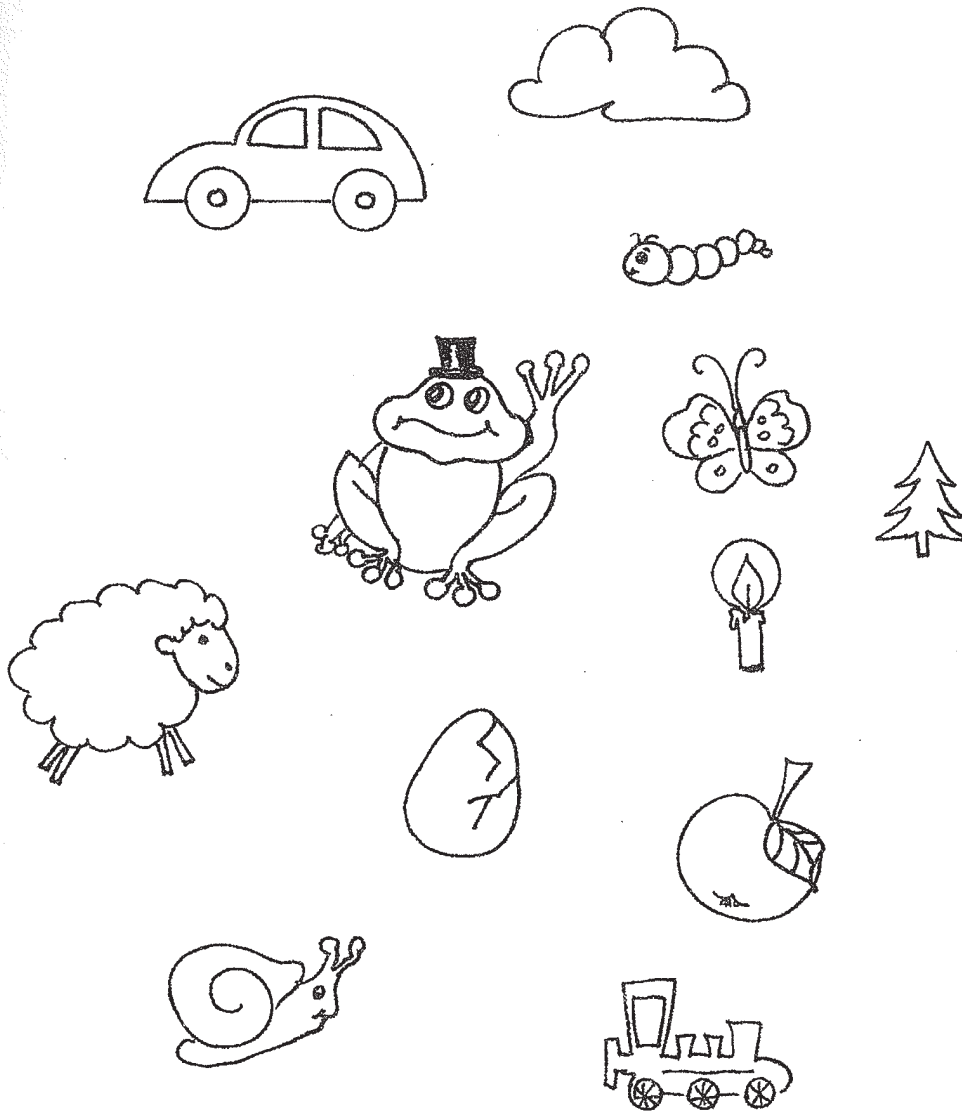

lytasd a sort!

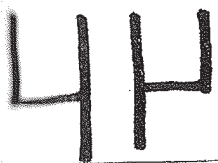
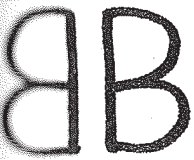
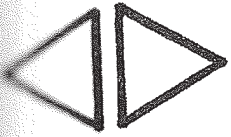

Árajzold meg a lepke másik felét!

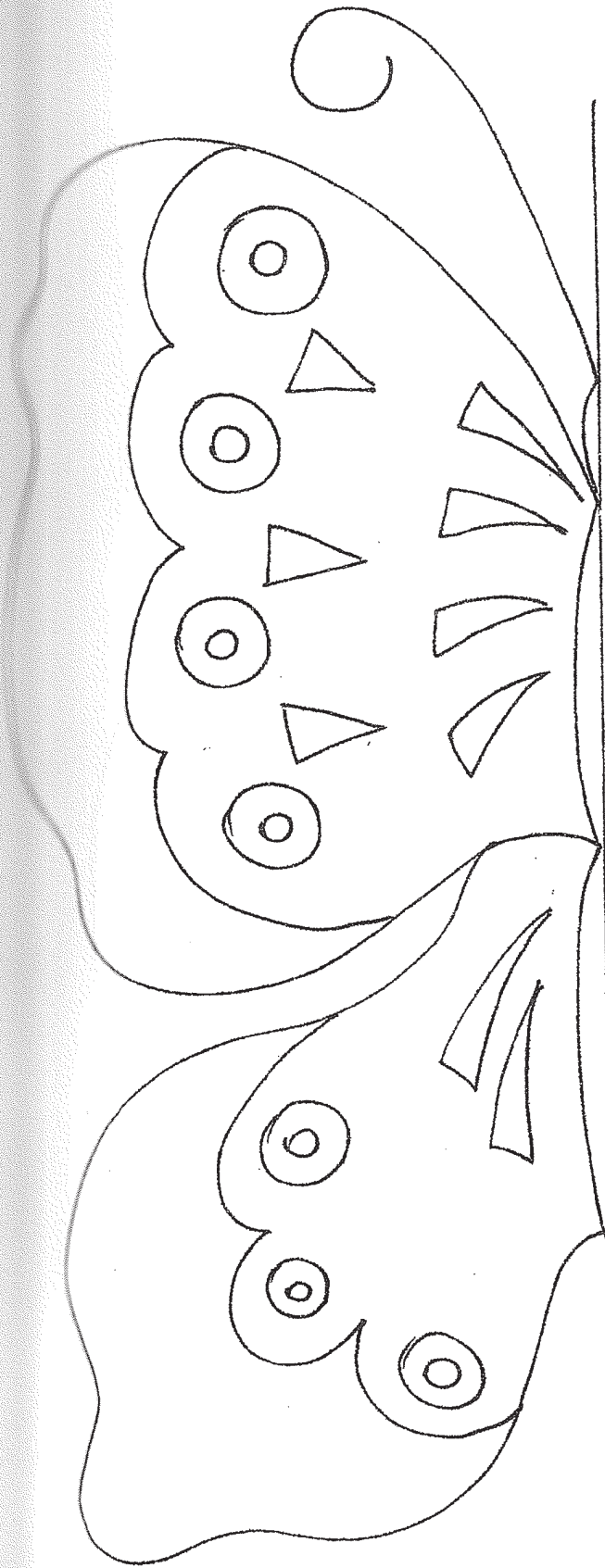

Színezd a lufikat különféle színűre!

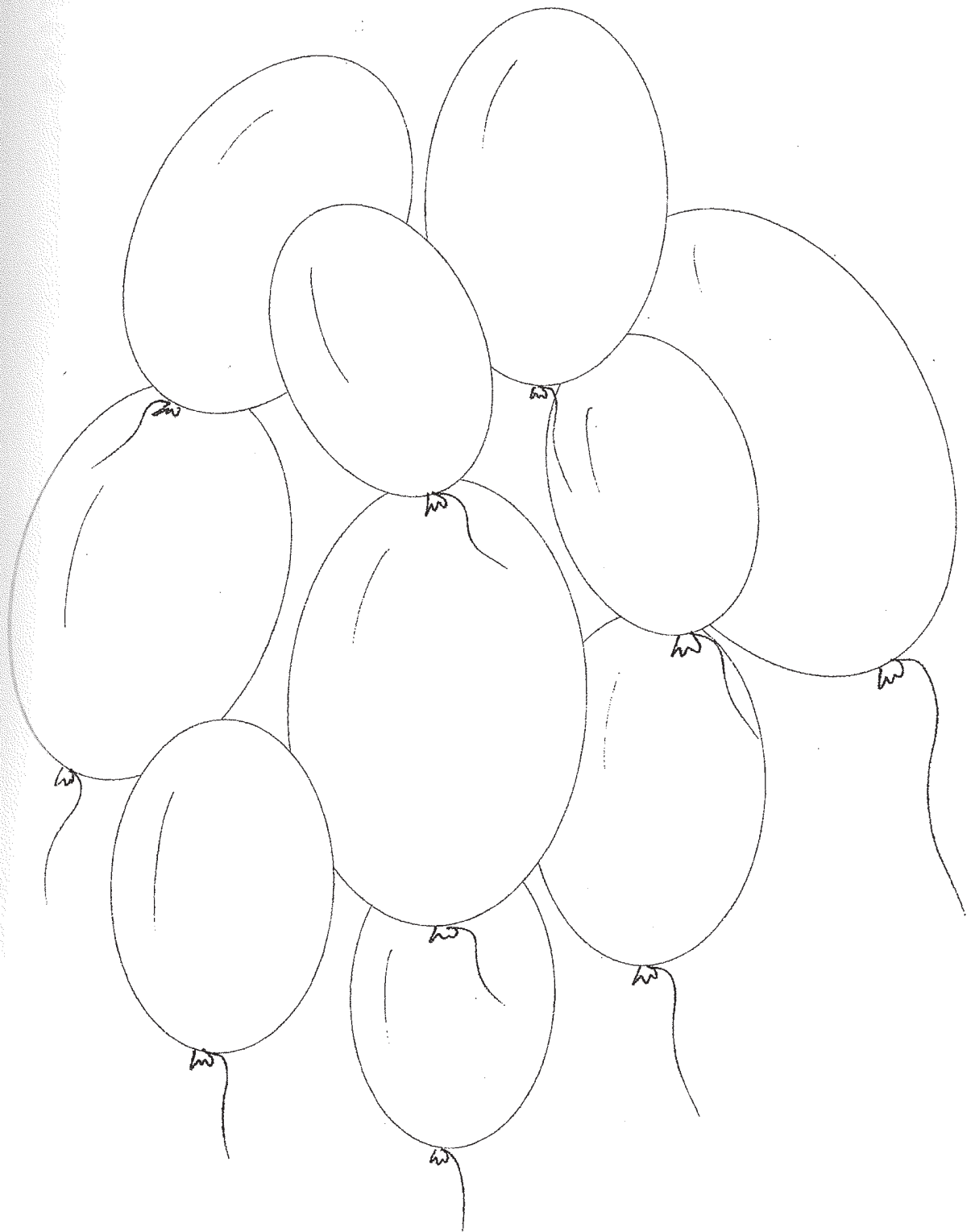

TÁRSASJÁTÉK

Az alakzatokat színezd ki és ragaszd kartonra. A vonal mentén vágd ki a négyzeteket. Kártyalapokat kaptál. Ezeket kell kirakni a másik oldalon lévő játéktáblára. Úgy kezded, hogy a kártyákat lefelé fordítod és összekevered. Ezután egyenként felemeled, és megkeresed a helyét a játéktáblán. Párban is lehet játszani. Az egyik tábla a tiéd, a másik a társadé. Az győz, aki előbb megtalálja és felrakja a kártyáit a játéktáblára.

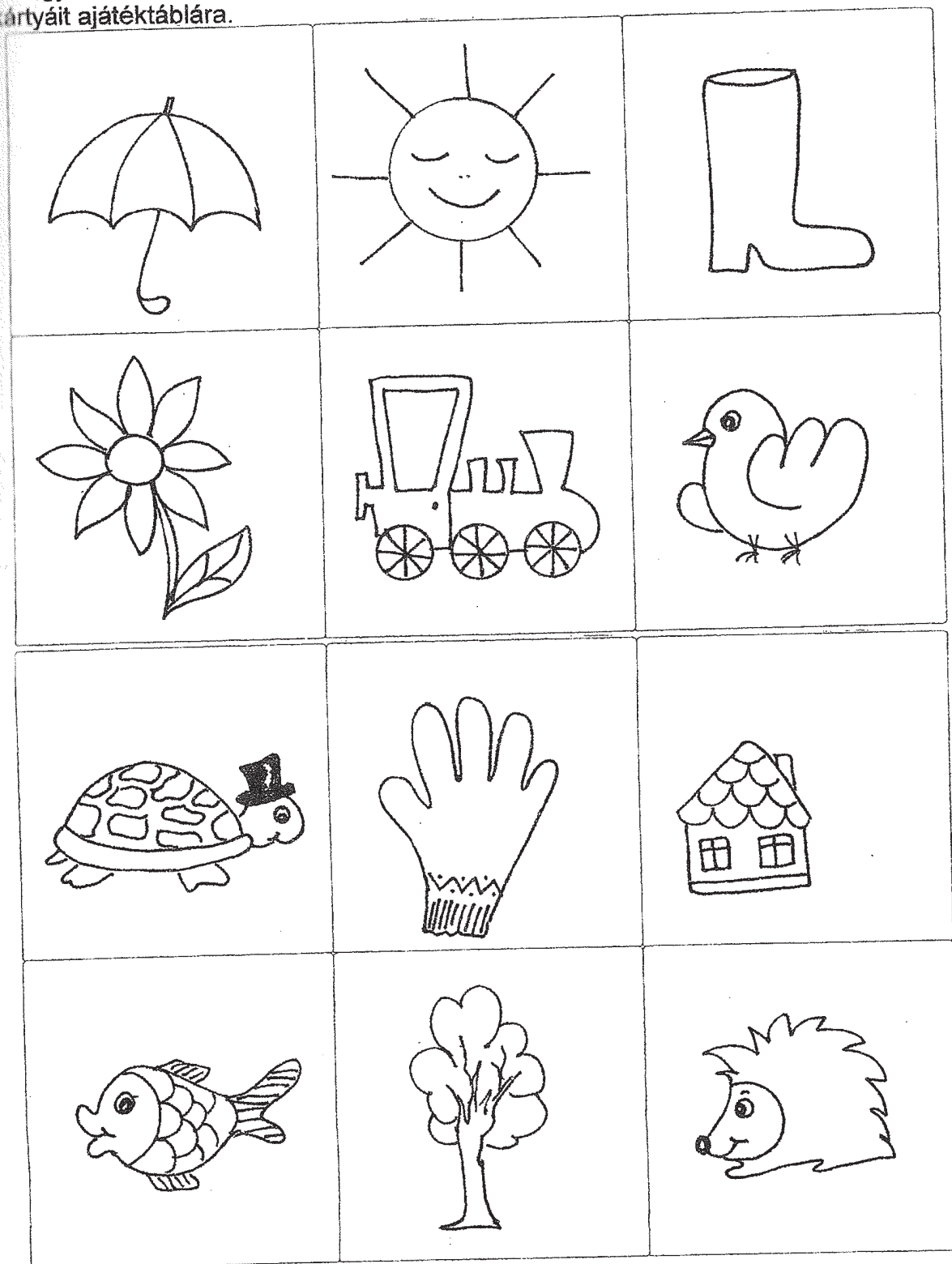

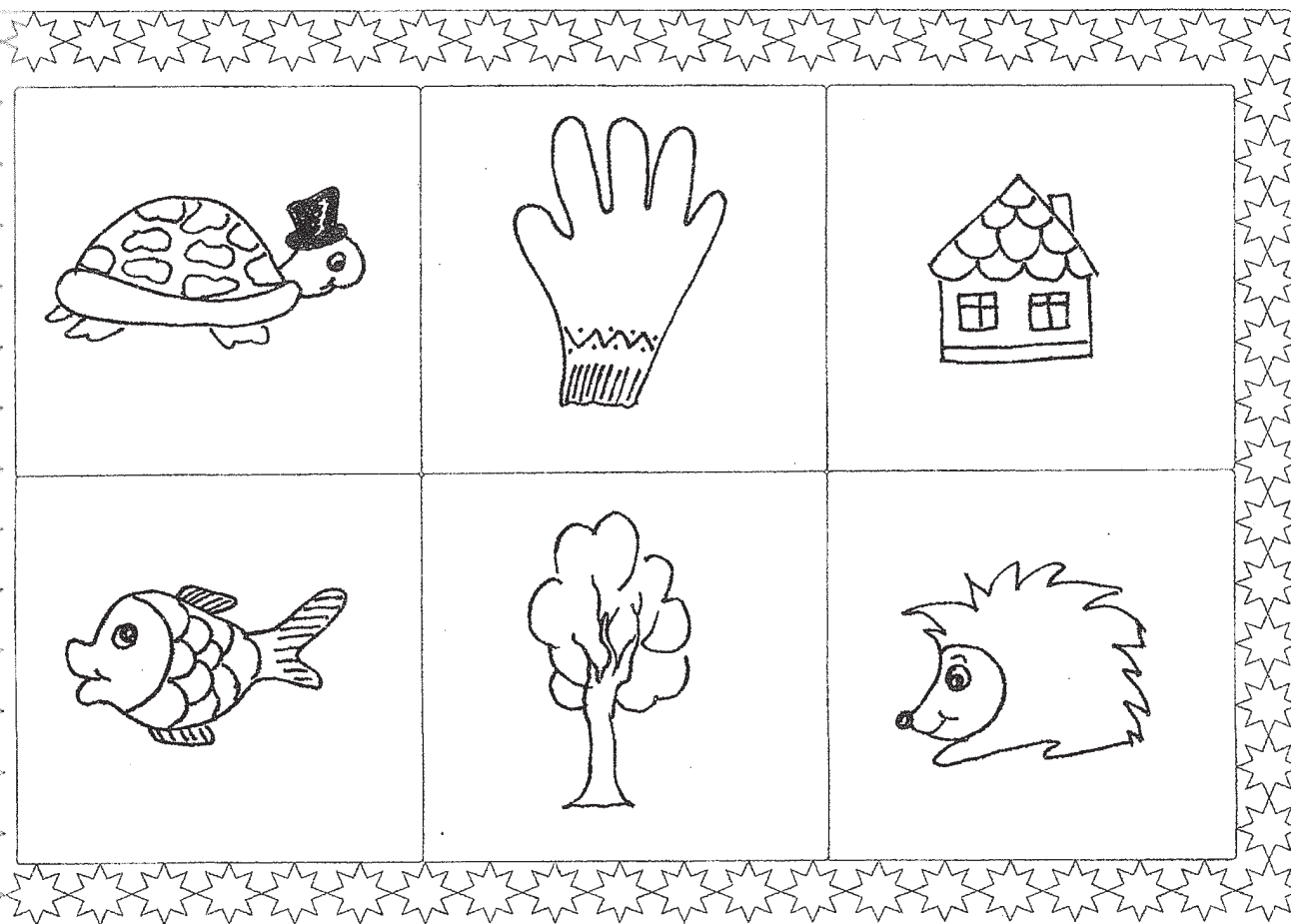
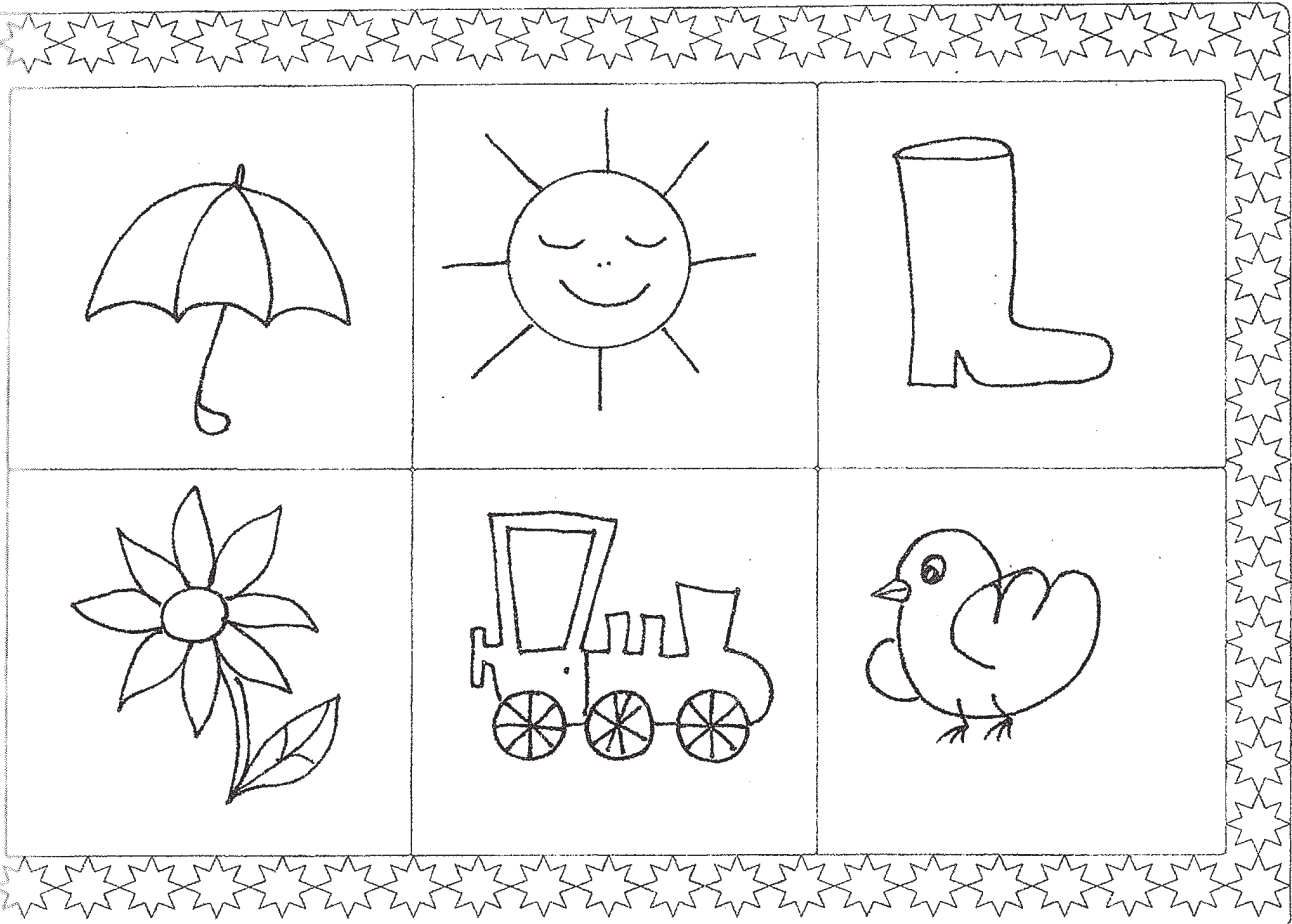

Guríts a kockákkal! Pótold a pontokat!

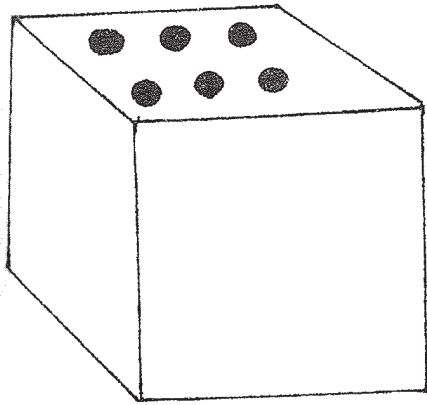

6

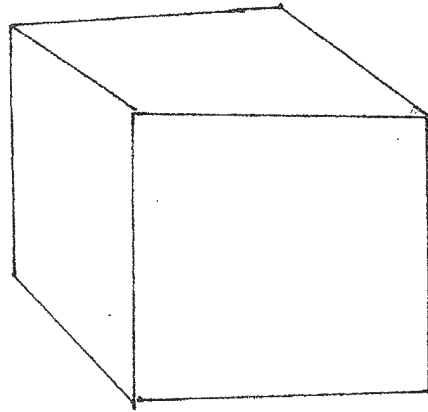

5

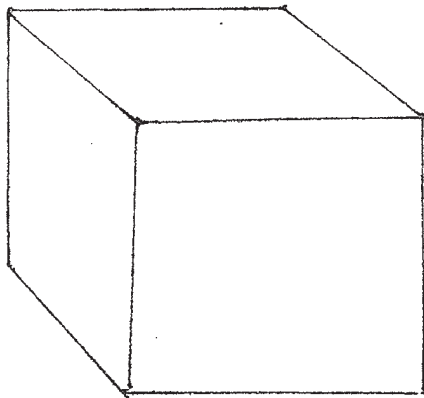

3

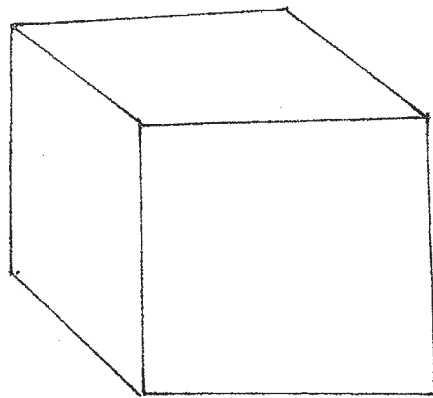

1

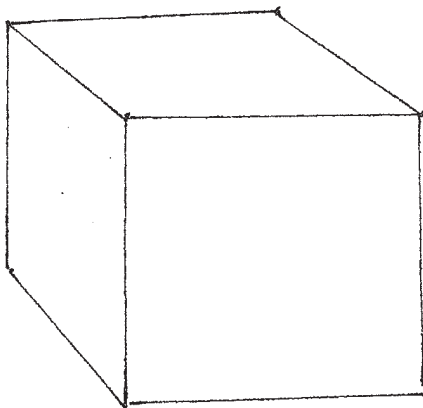

4

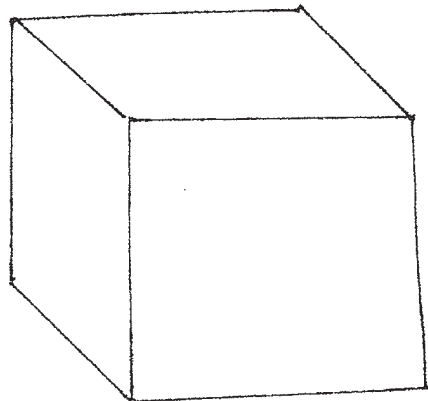

2

Színezd ki a mandalát!

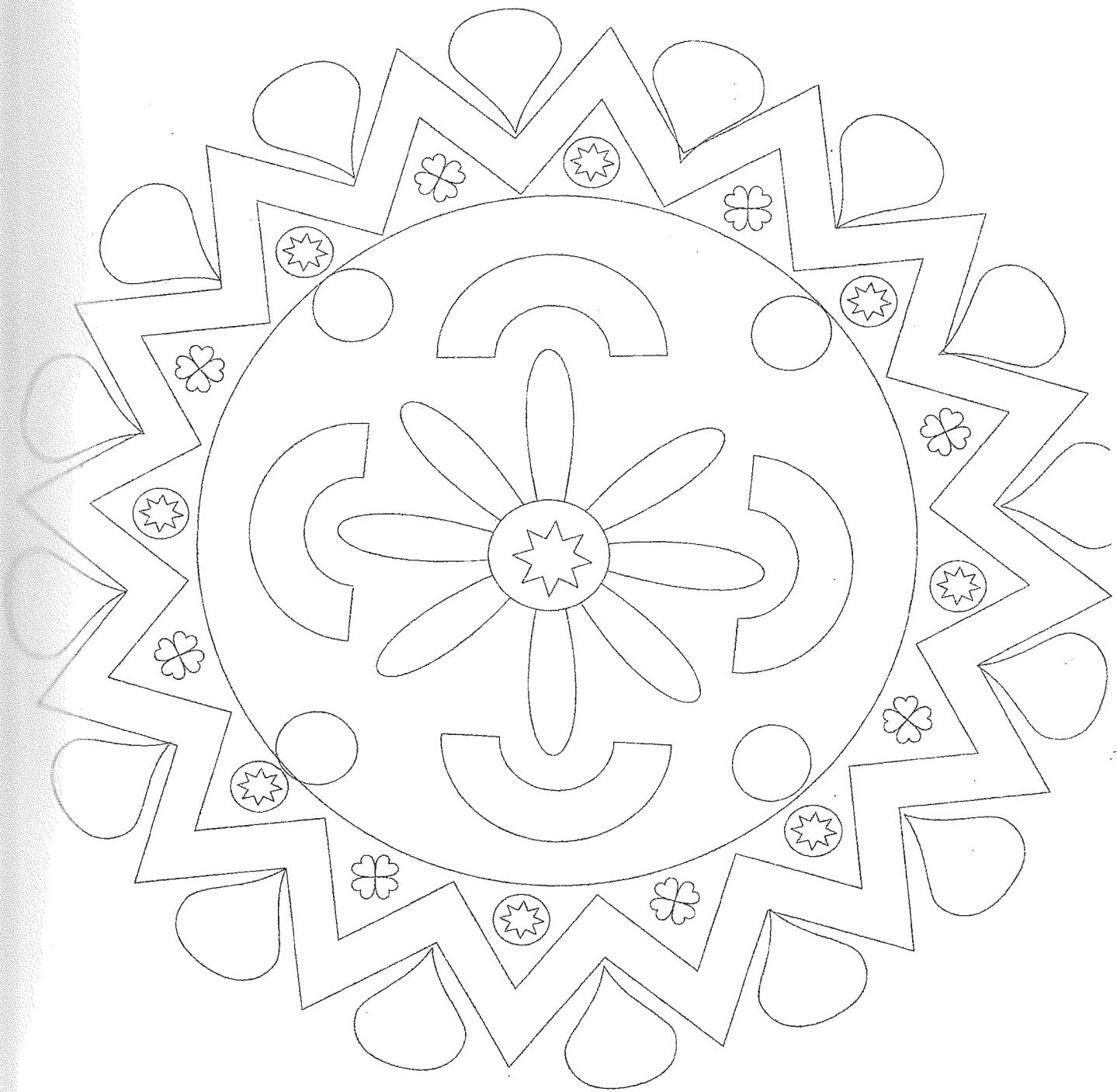

Tervezz te is mandalát!

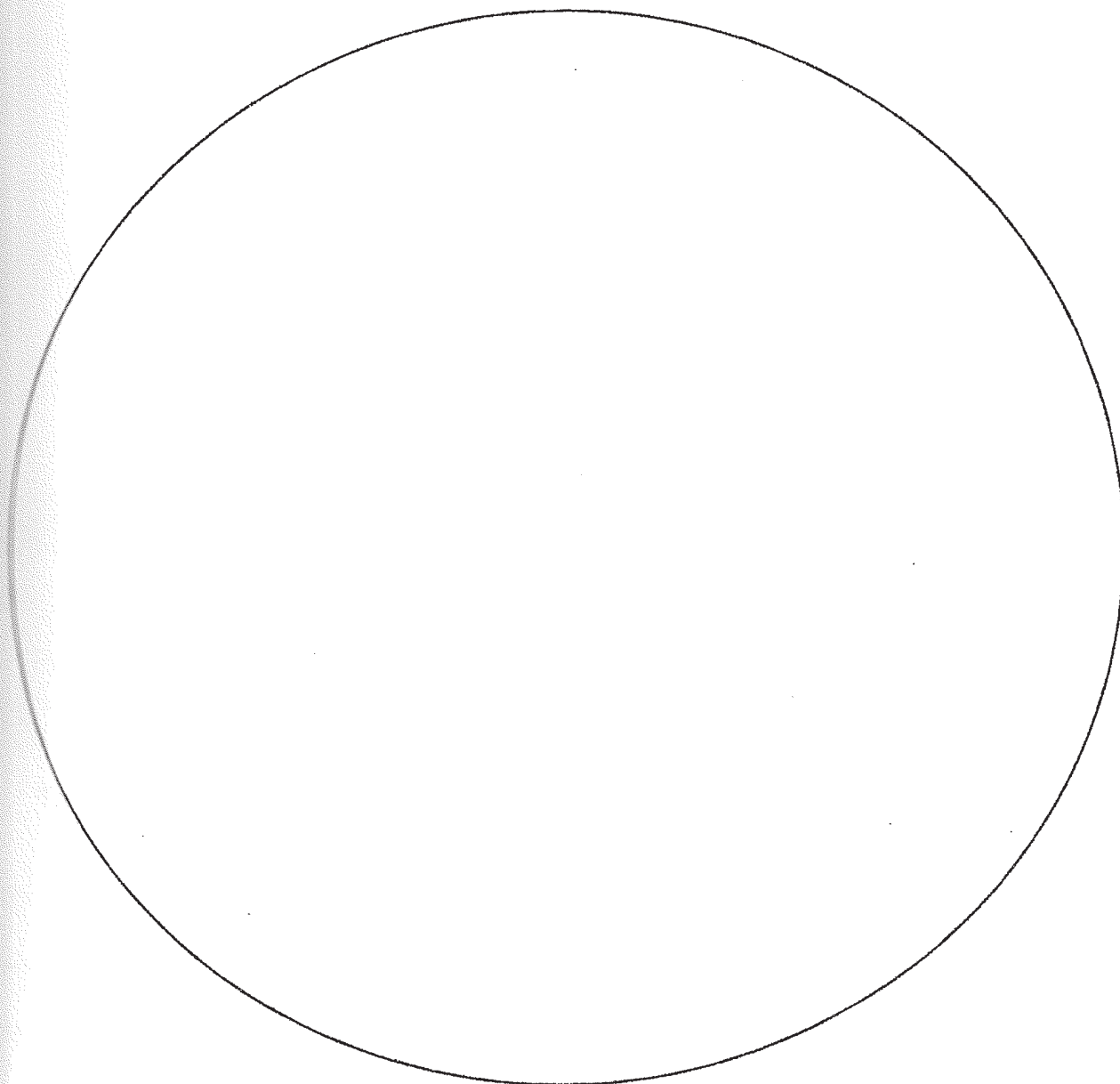

Csak a téglalapokat színezd ki!

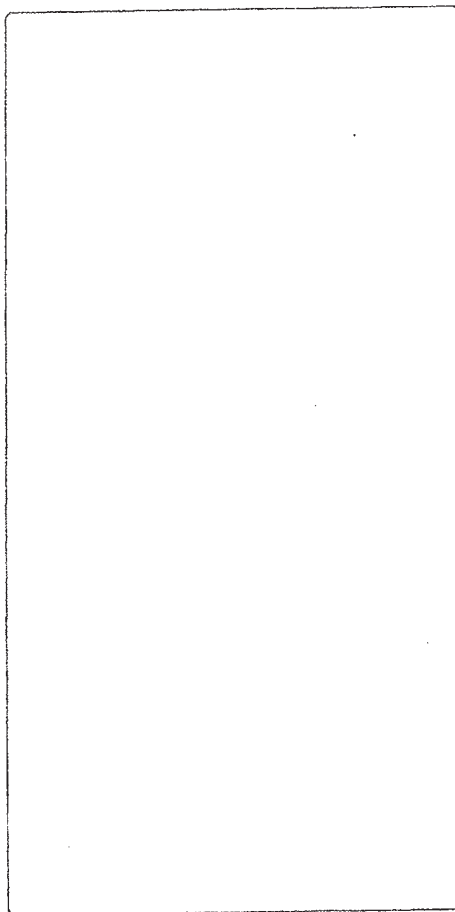
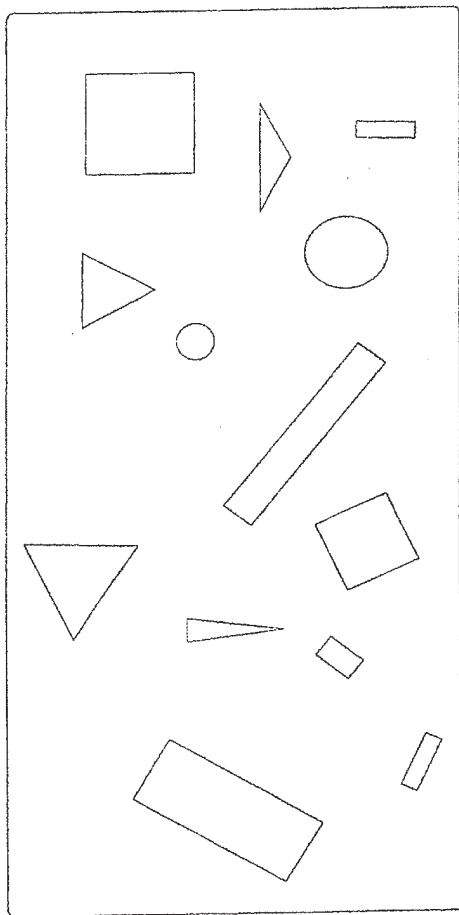

Tegyél pontot a négyzetek közepébe jobb kézzel!

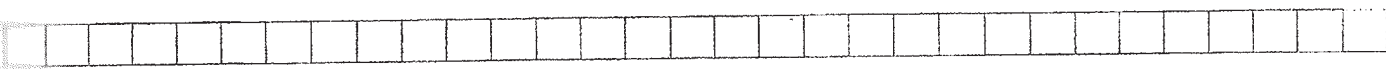
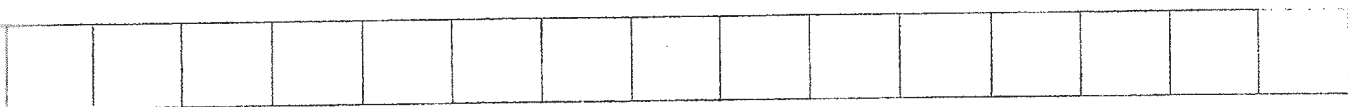

Tegyél pontot a négyzetek közepébe bal kézzel!

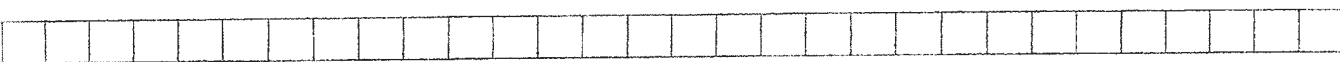

Rajzolj a körte mögé almát!



Rajzolj a szőlő mögé körtét!

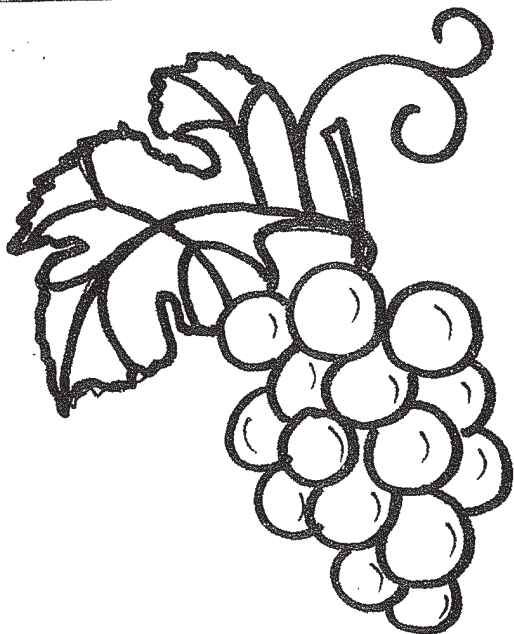

Folytasd a sort!

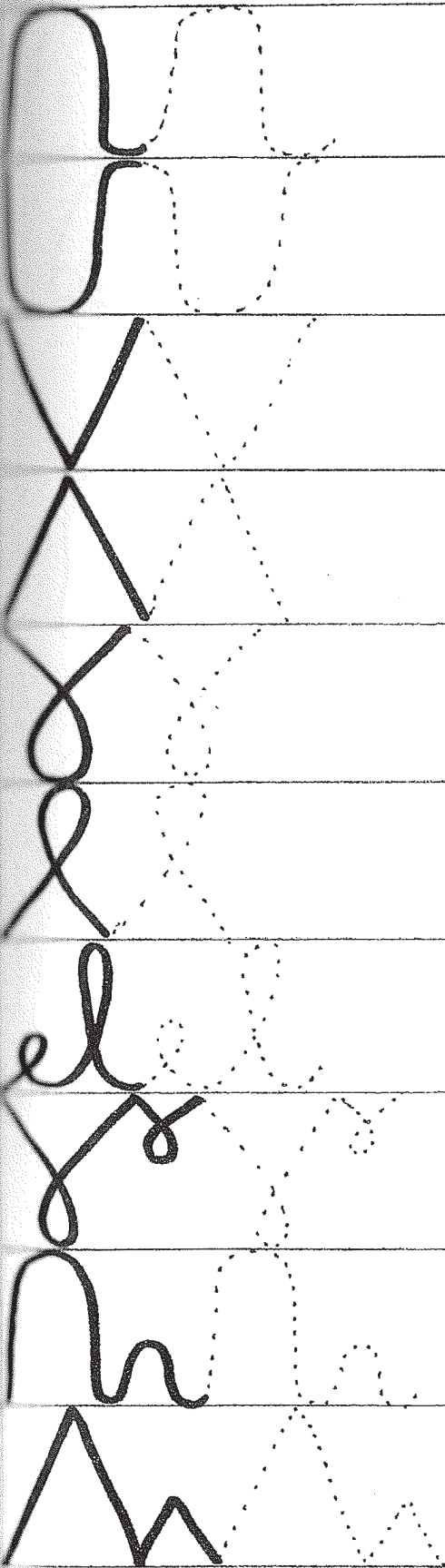

Vezesd el az elefántot a fához reggelizni!

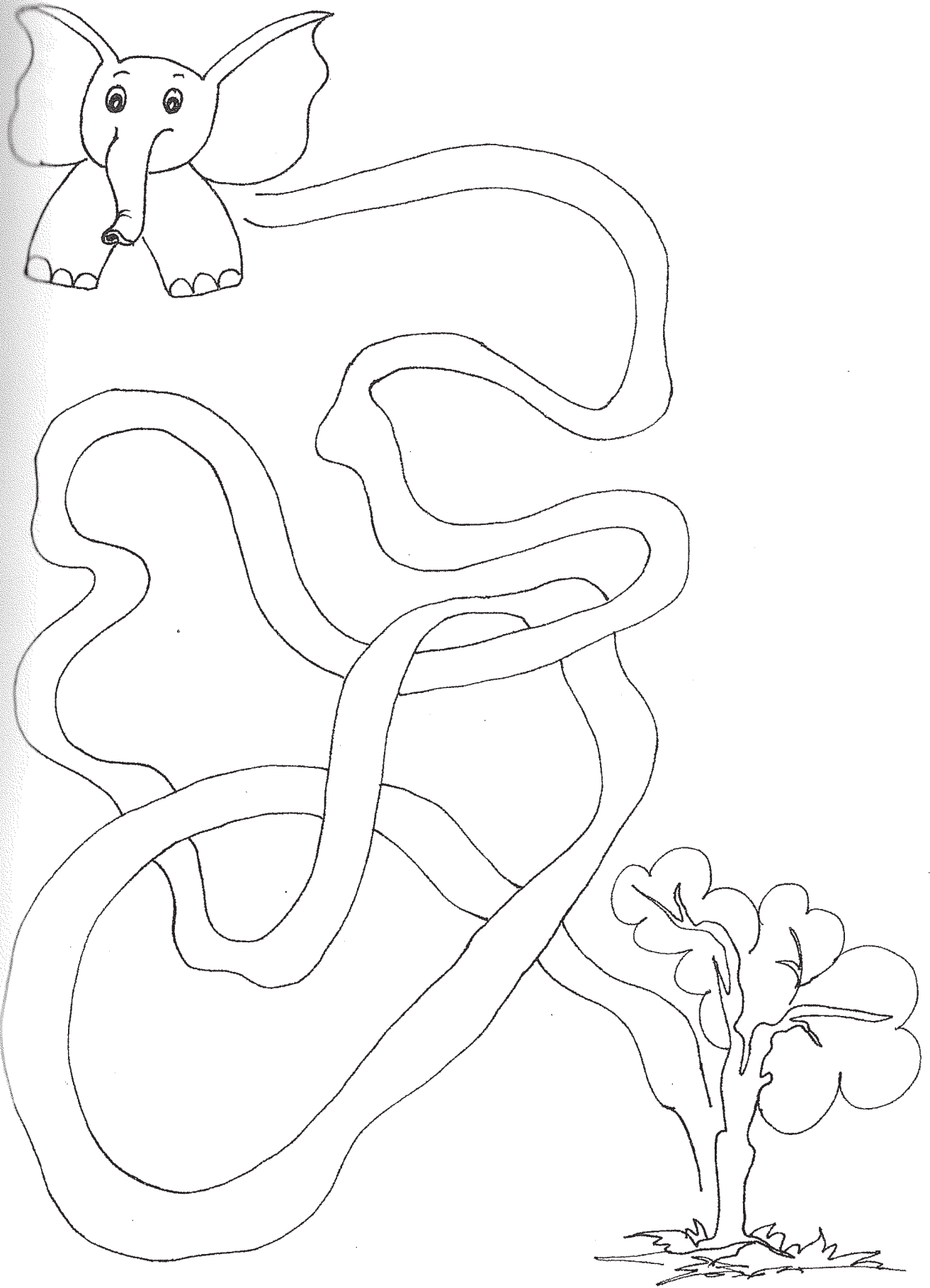

Rajzolj a ház fölé felhőt, alá fűvet, mellé fát!
Rajzolj a felhő mellé napot, a fára almát, a fűre virágot!
Rajzolj a ház alá tavat, a tóra kacsát!

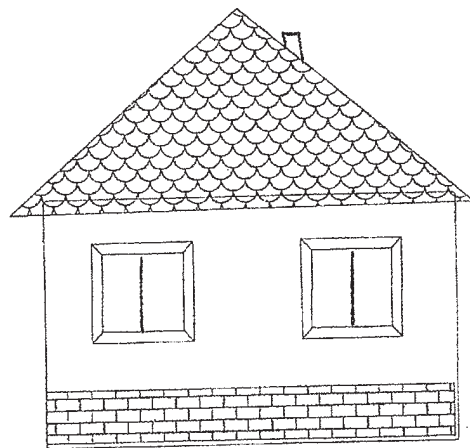

Rajzolj vonalat egyszerre mindkét kézzel!

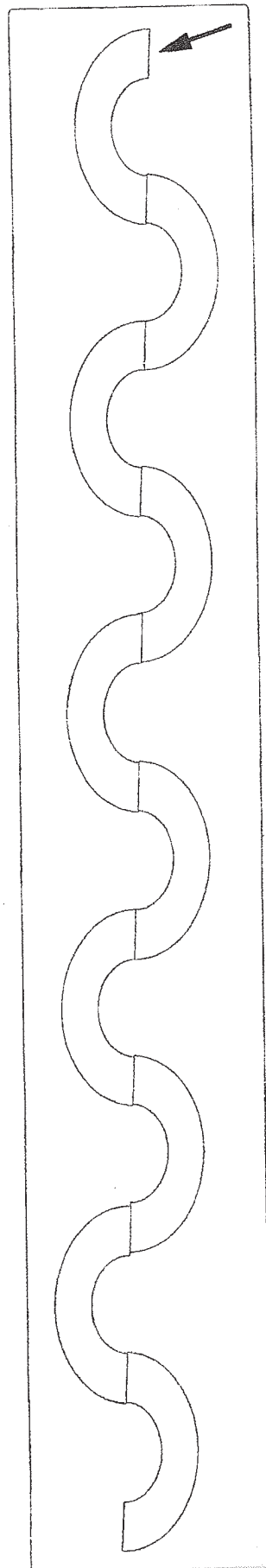
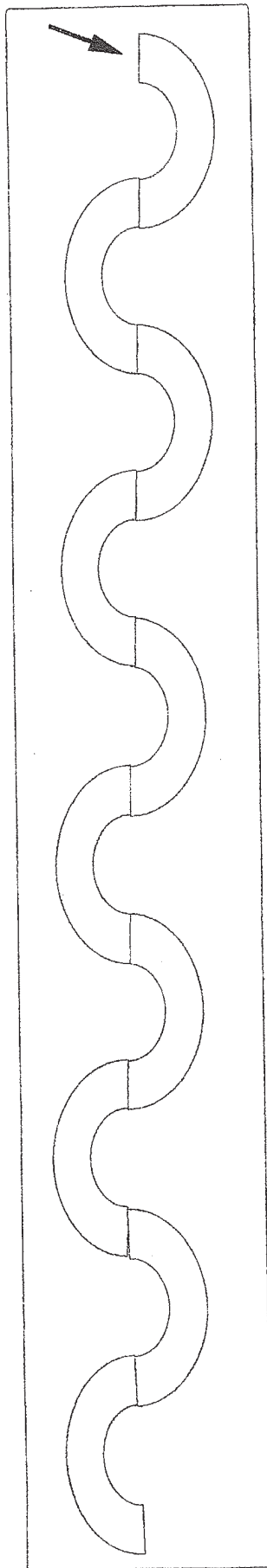
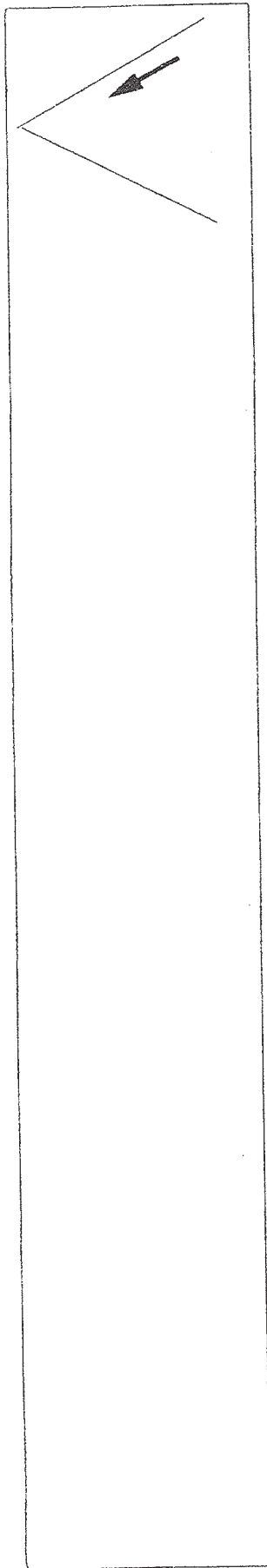
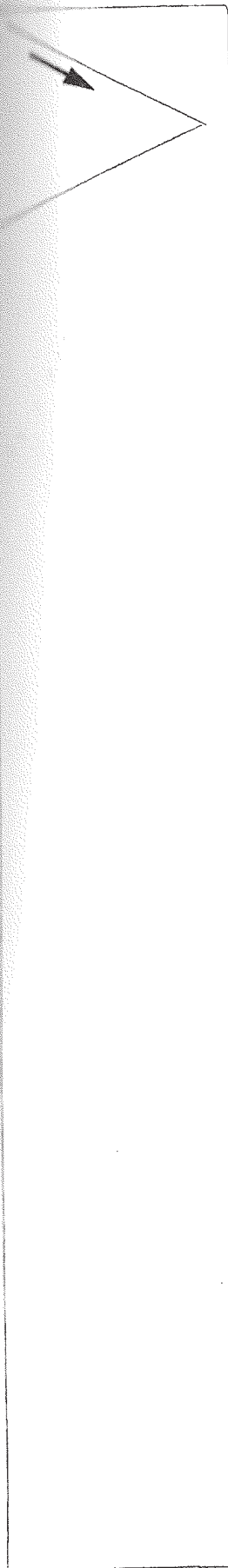

Rajzolj mindkét kézzel kívülről befelé!

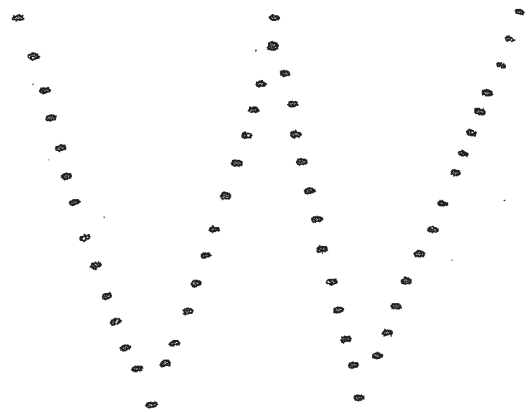
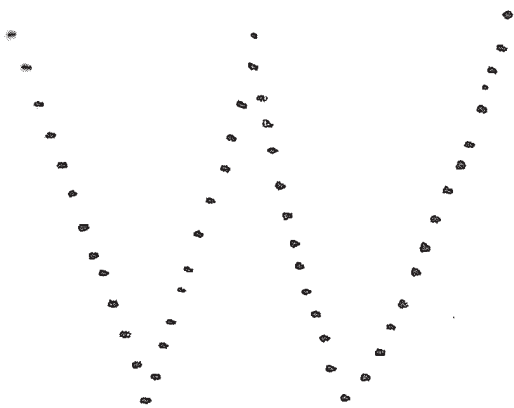
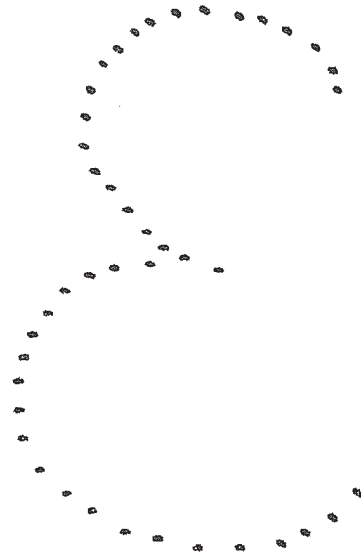
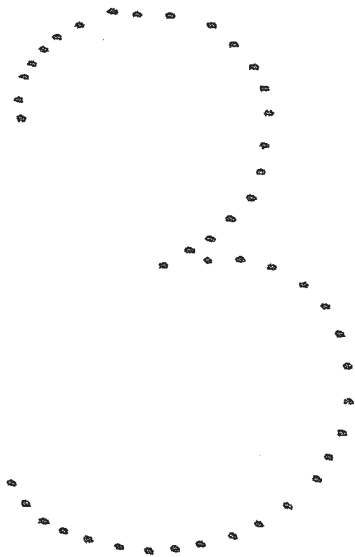
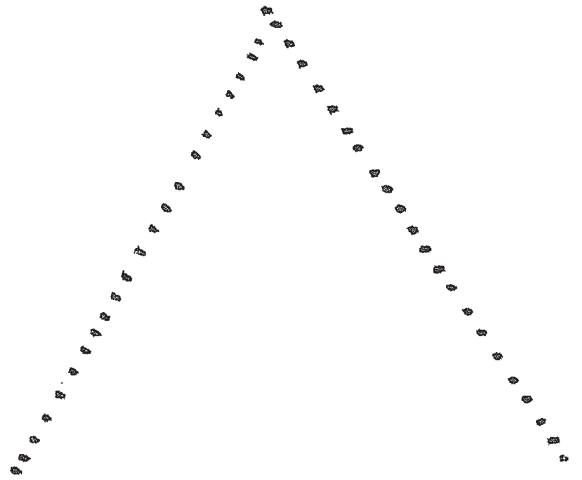
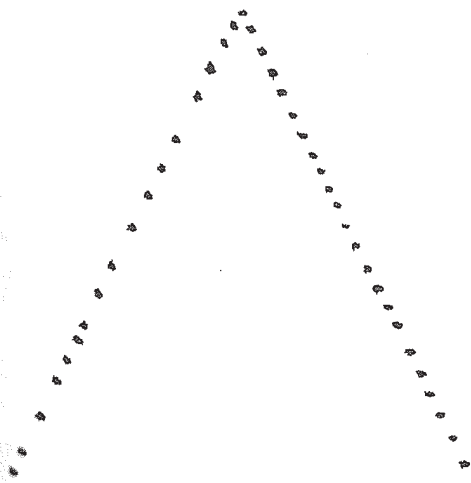

Színezd ki a tojásokat!

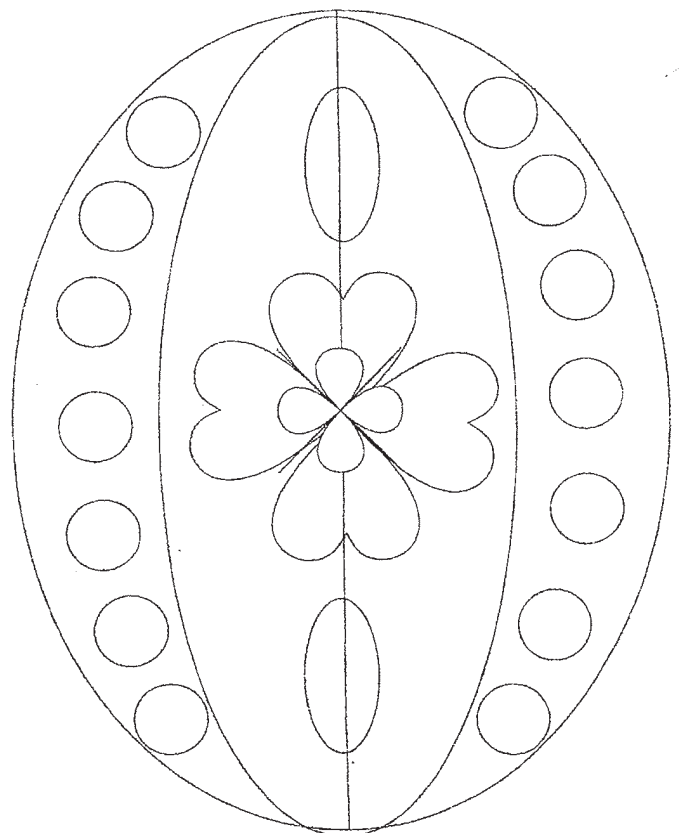
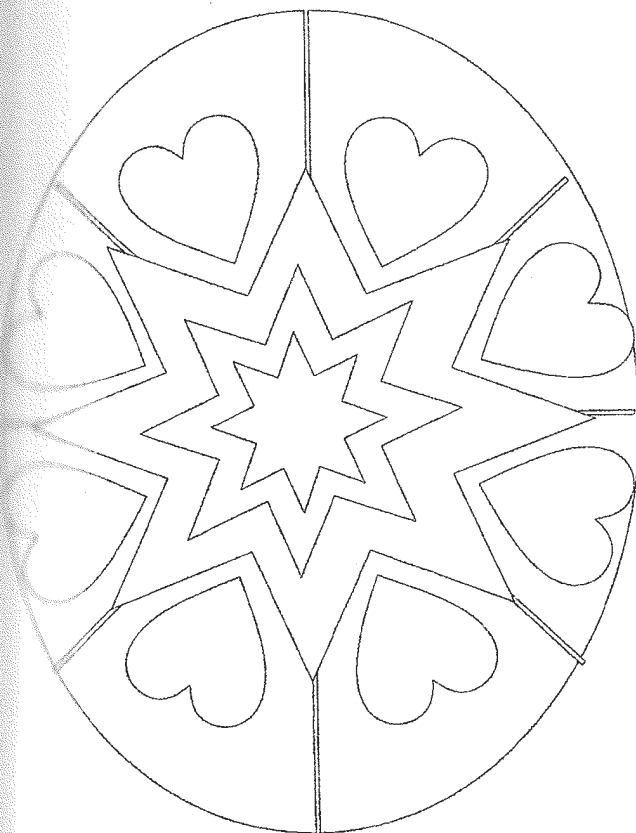
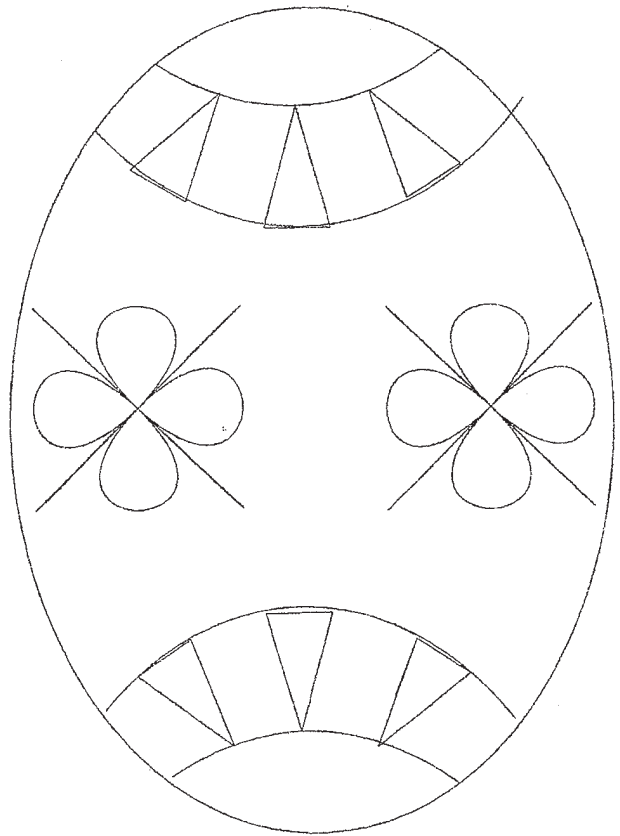
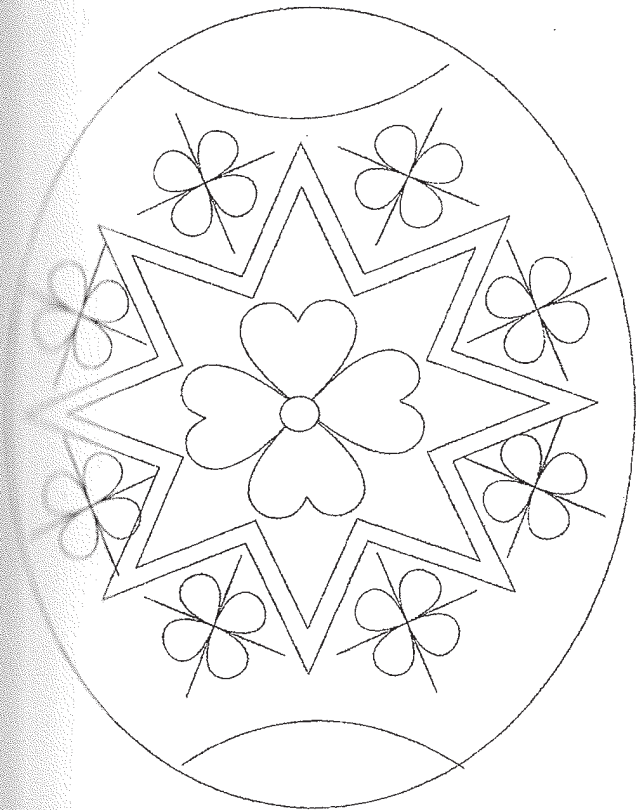

Papírhajtogatás

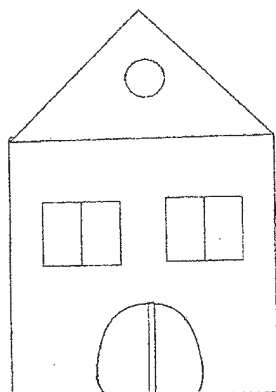
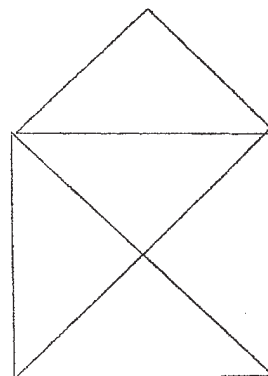
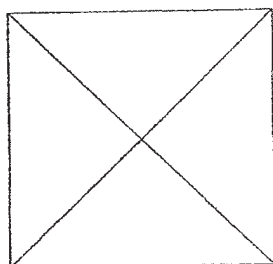
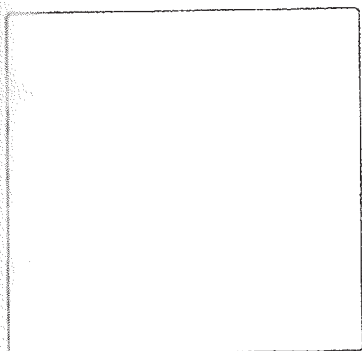

Bábszínház

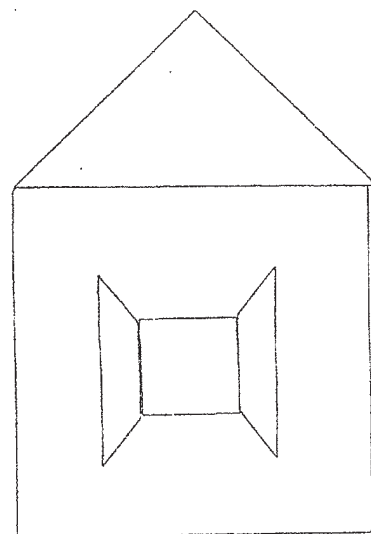
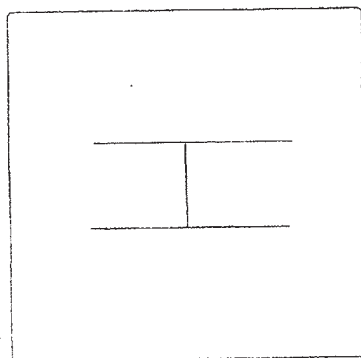
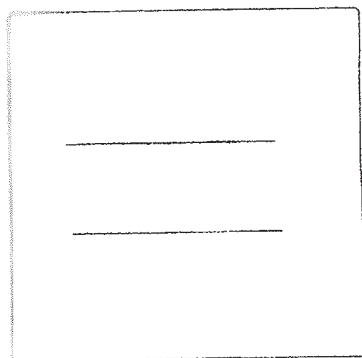

Minták ujjbábokhoz

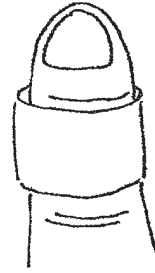

Mesejáték: A kis sárga tyúk

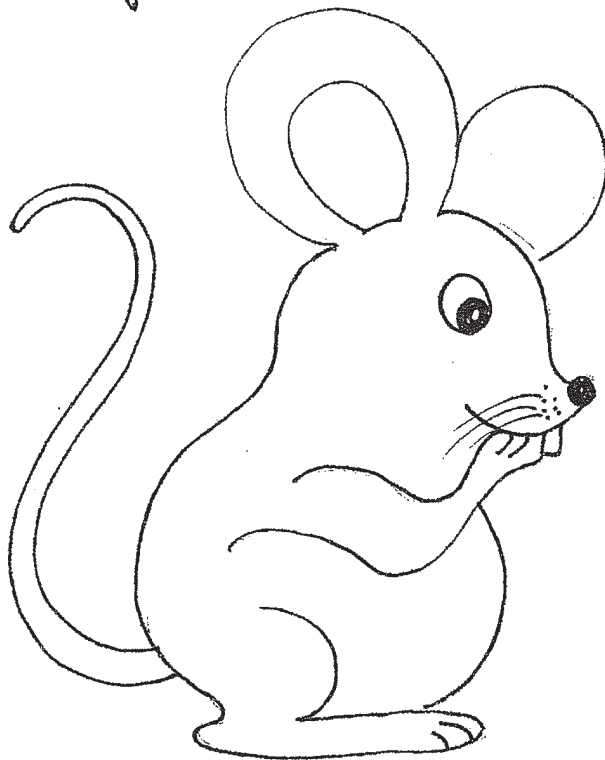
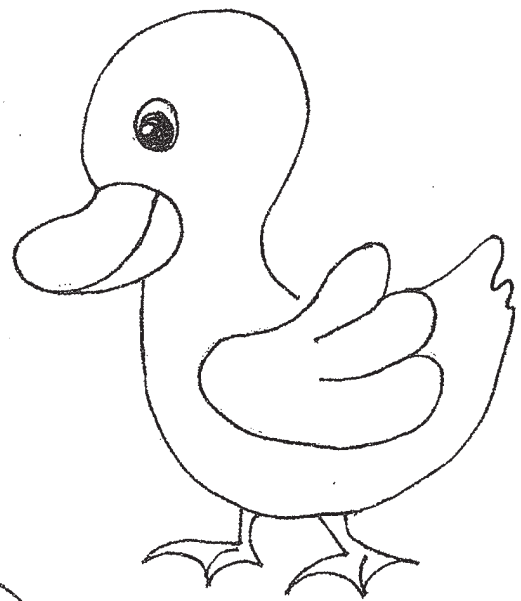
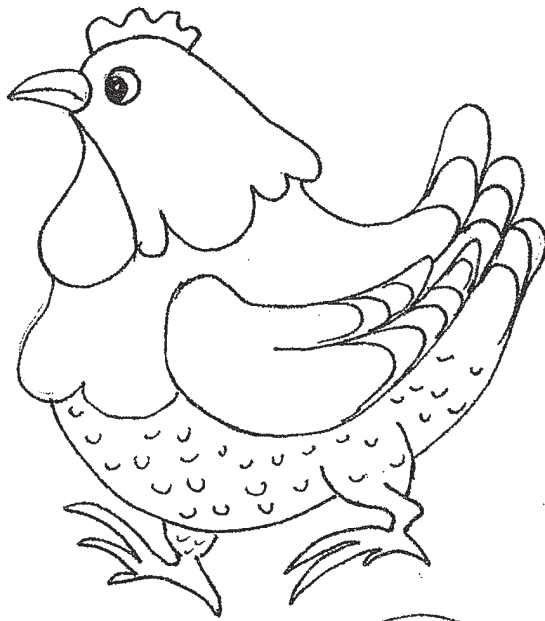

Víziló a Nilusban! Színezd a vizet világoskékre és sötétkékre.

A vonal mentén vágd ki!

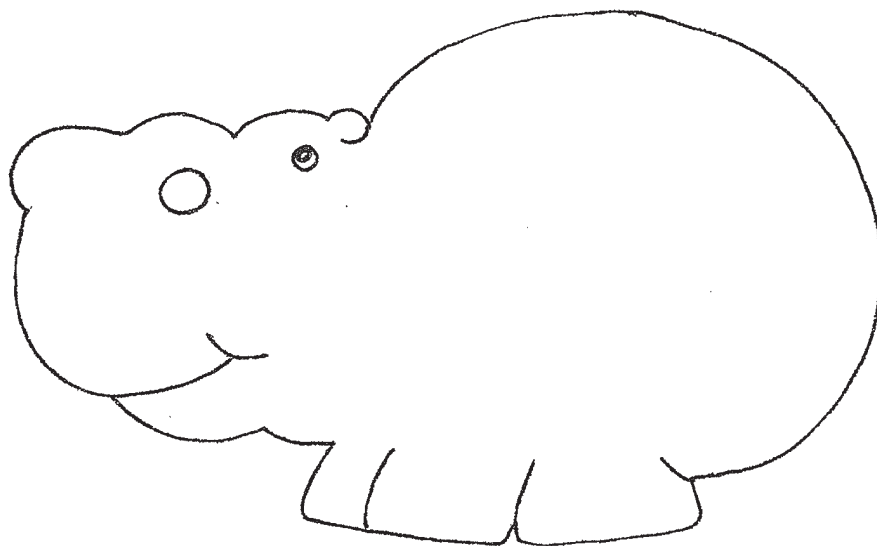
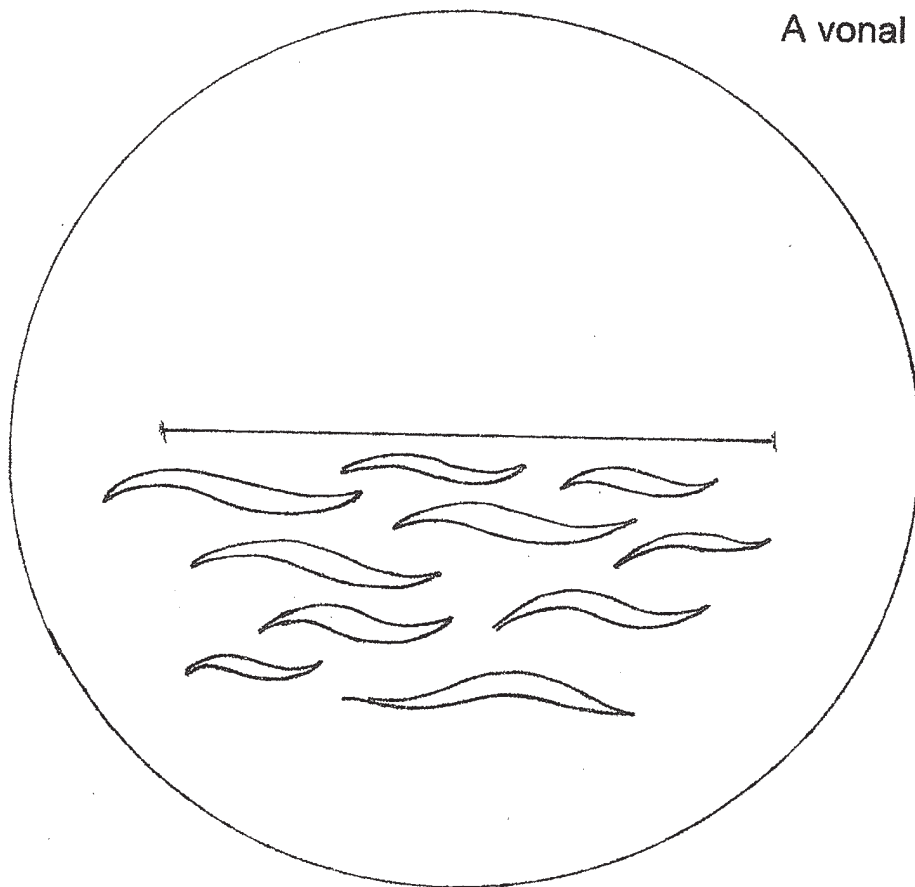

Színezd ki a vízilovat, vágd ki, és tedd a vízbe!

Ilyen gyöngyöket fűzzél fel a nyakláncra!

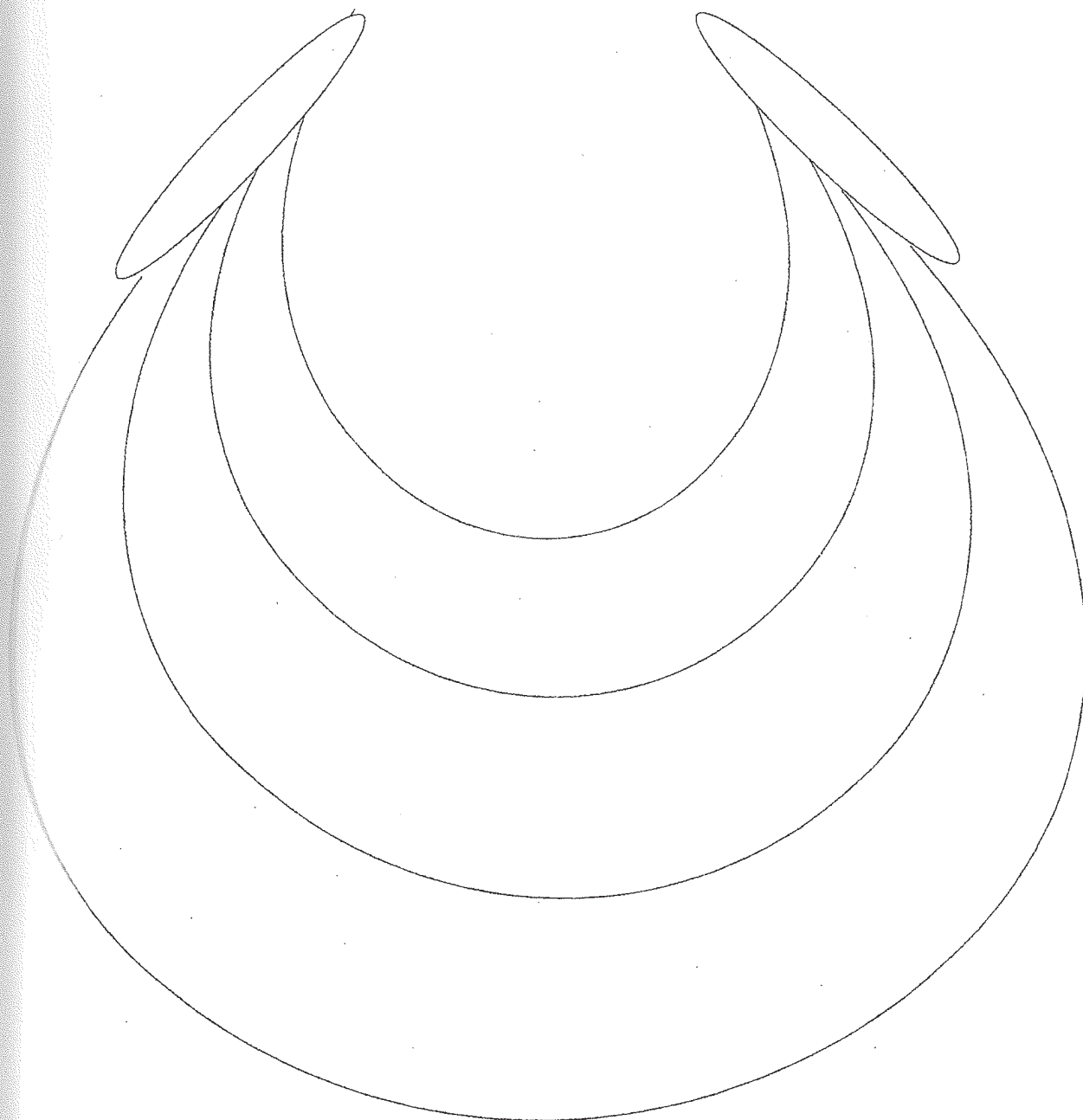

Rajzolj téli öltözéket a babára!

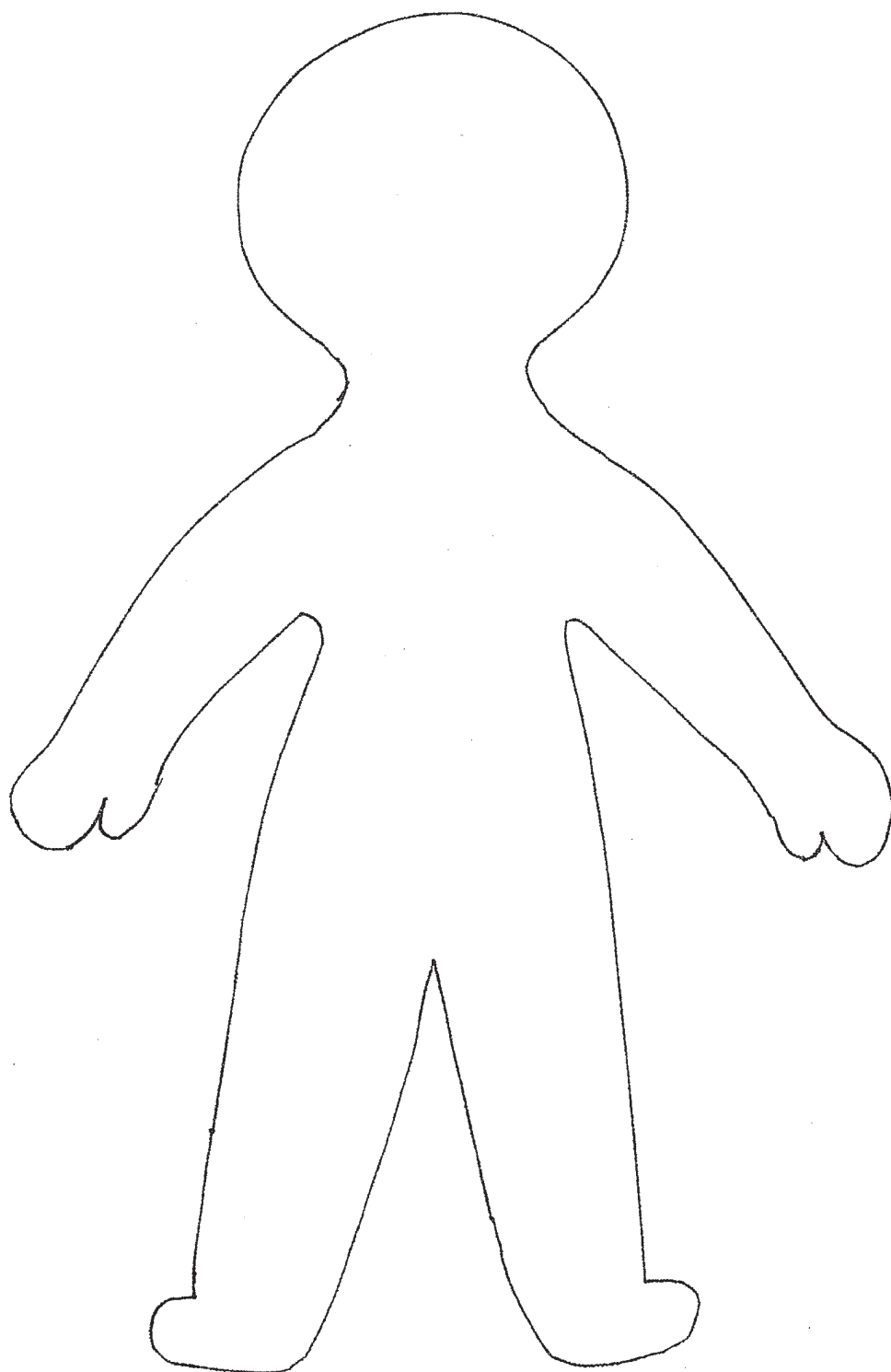

Rajzolj nyári öltözéket a babára!

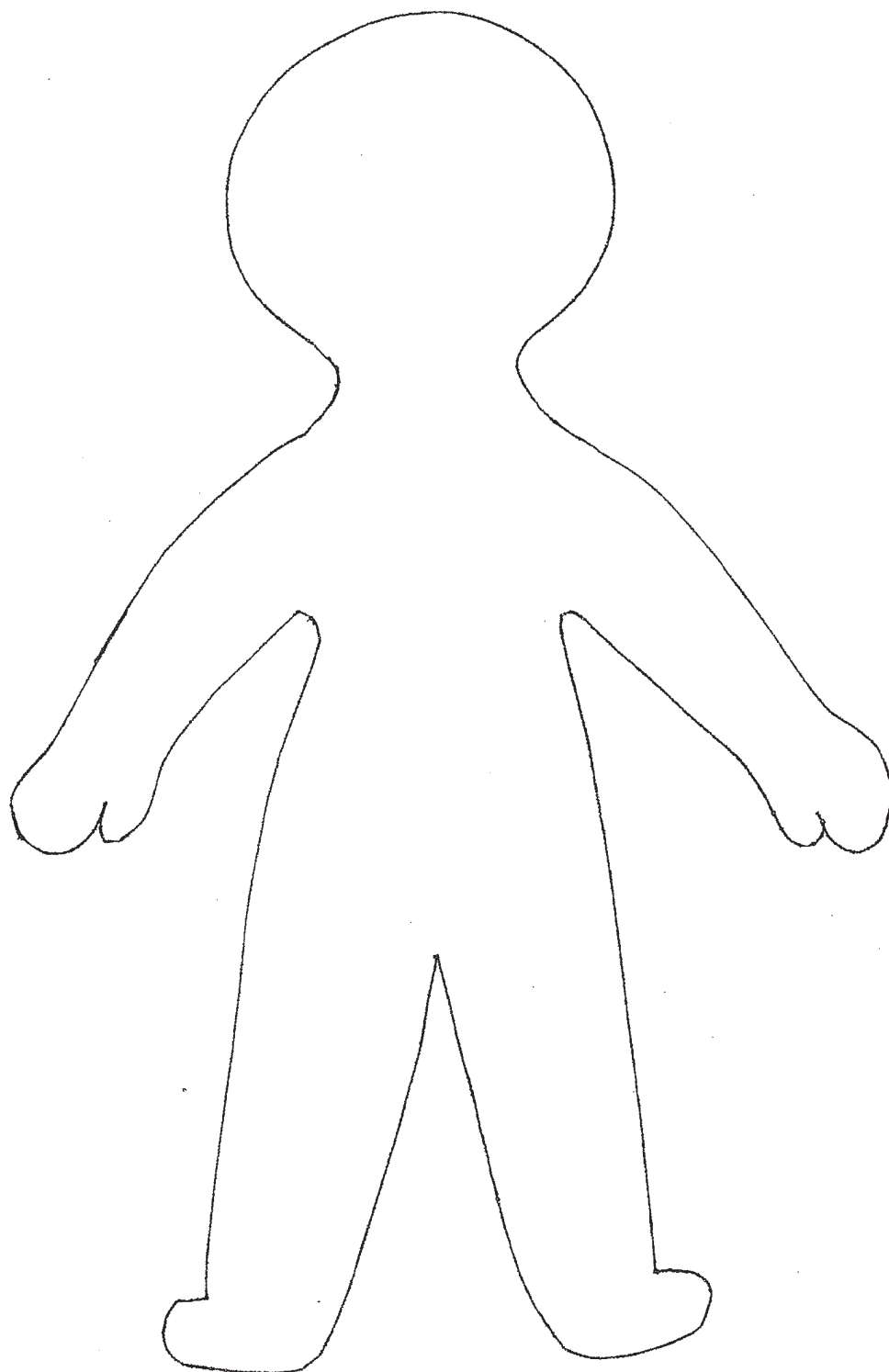

Párosítsd össze az összetartozókat! Ezután rajzold meg az egész képet!

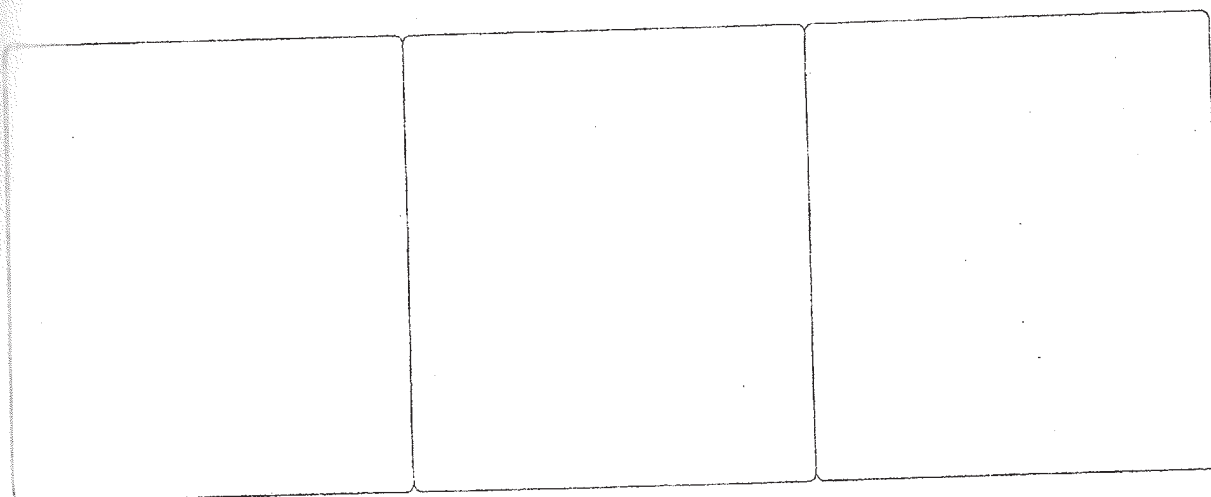
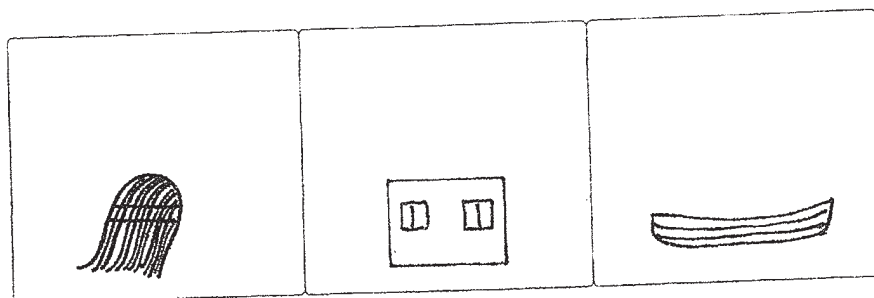
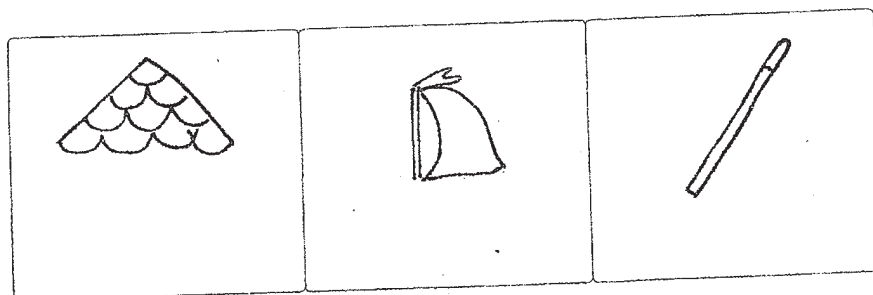

Mindegyik rajzot kösd össze az árnyékával!

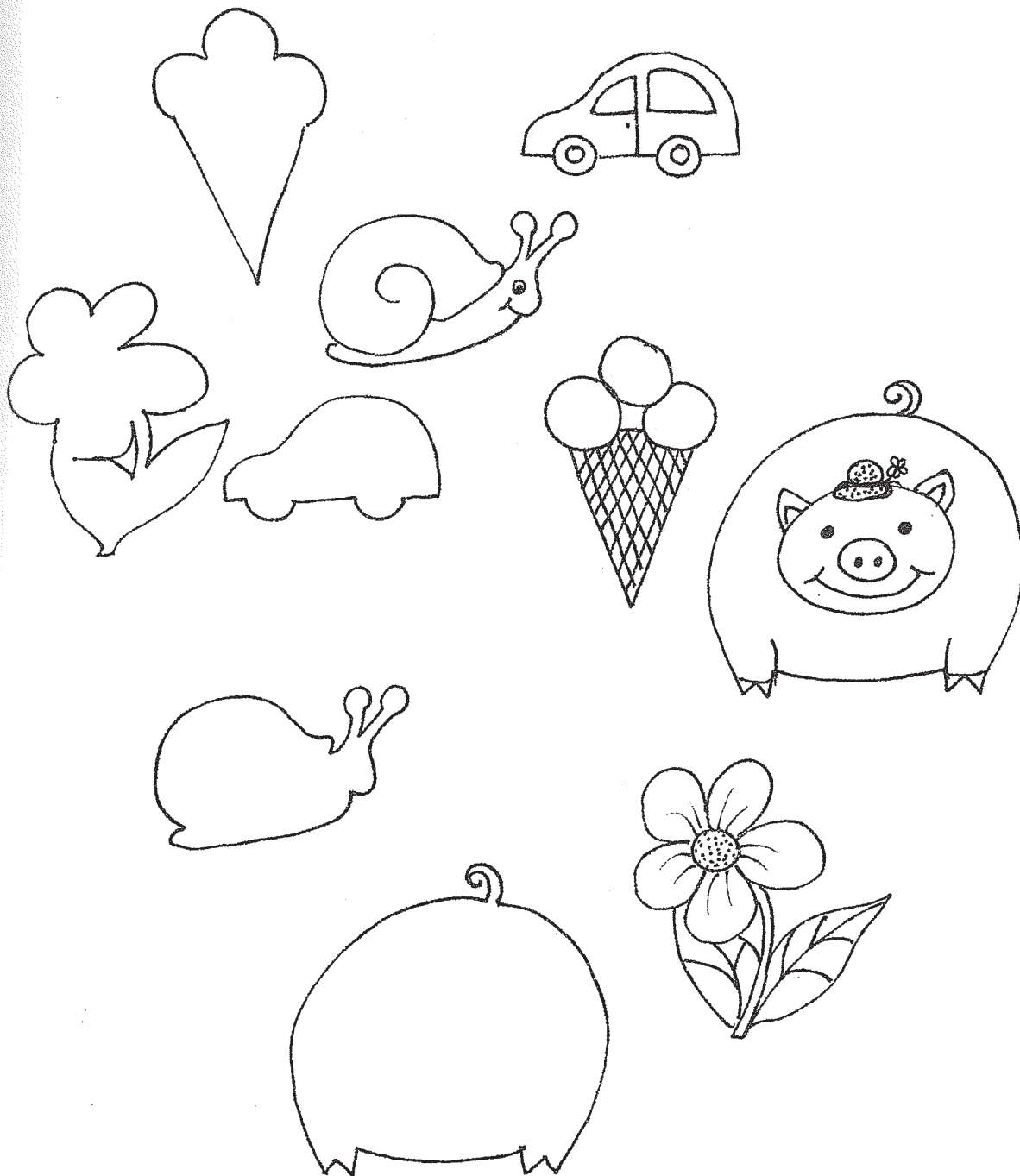

Tervezz szőnyegmintát!

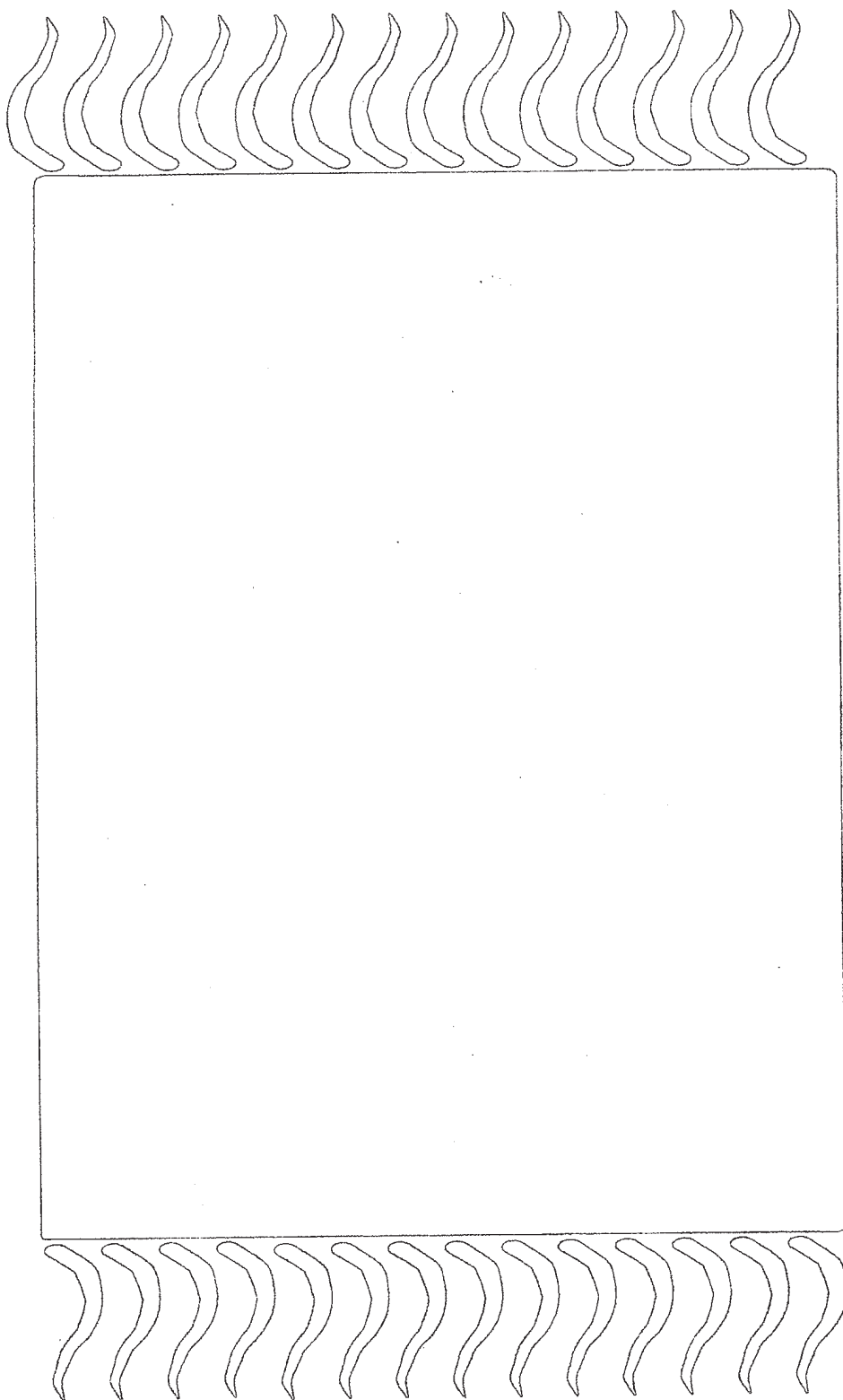

Rajzold le, hogy mi van a táskában!

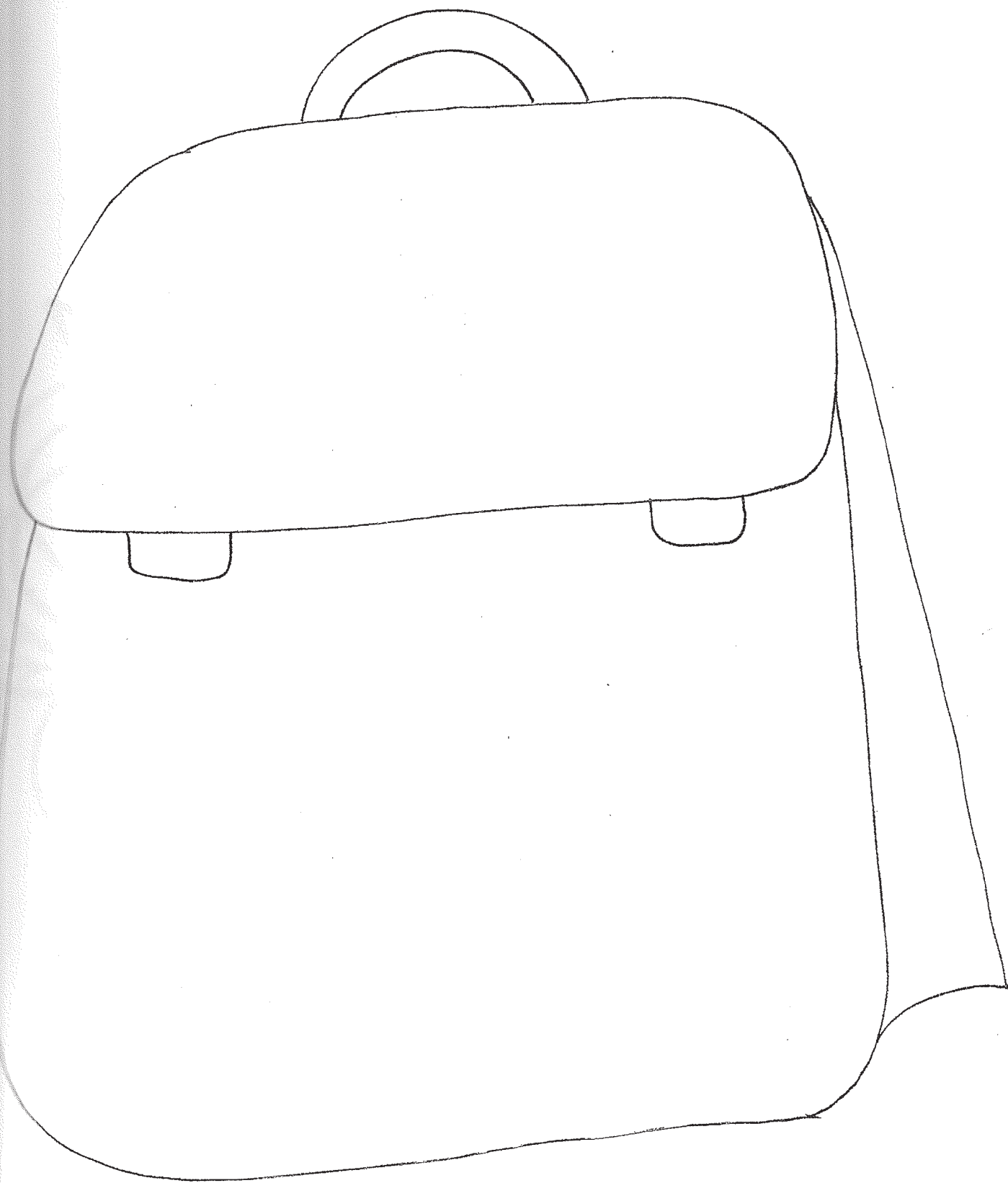

Színezd ki a mandalát!



Háziállatok – Vadállatok

Melyik él a ház körül, és melyik az erdőben?

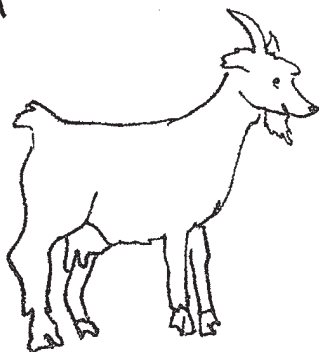
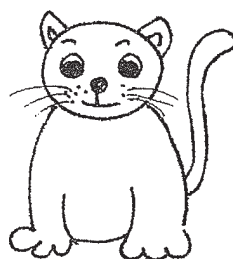
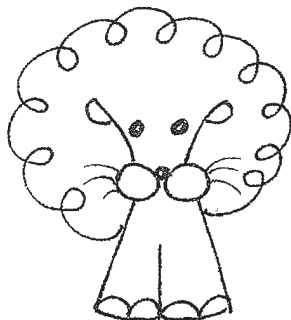
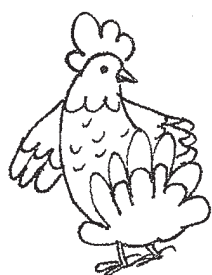
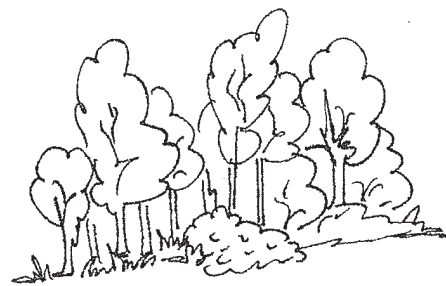

foldsd meg a befőttés üvegeket!

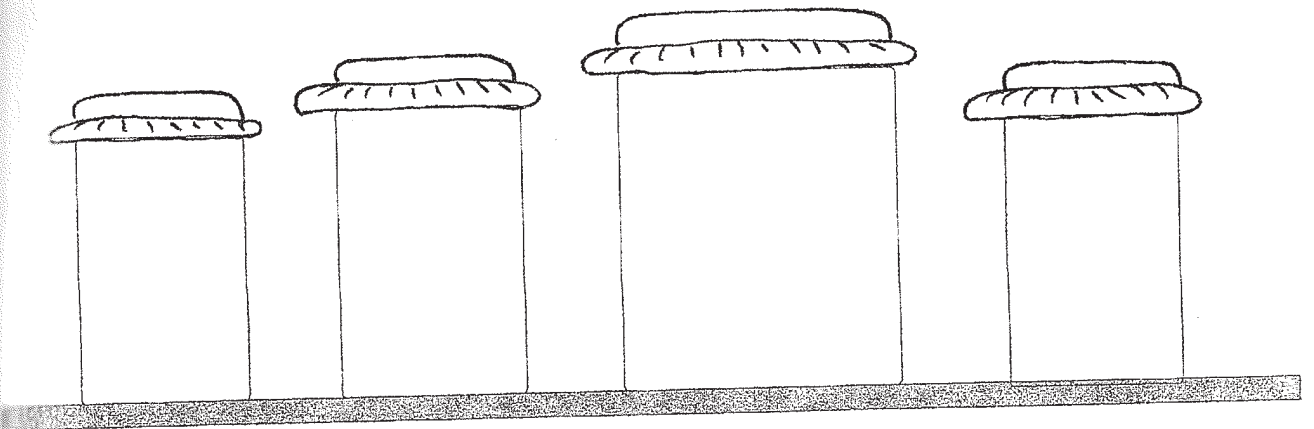
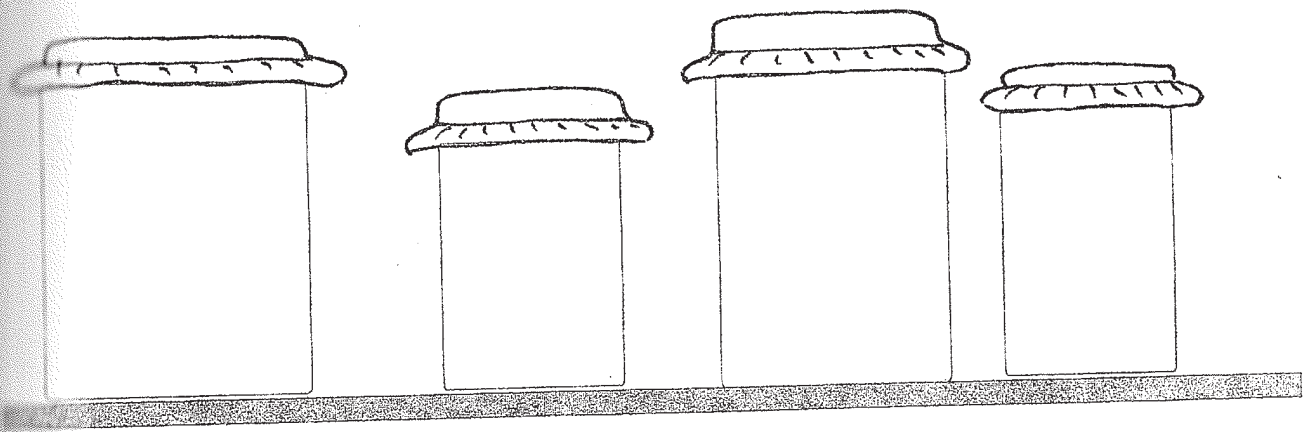
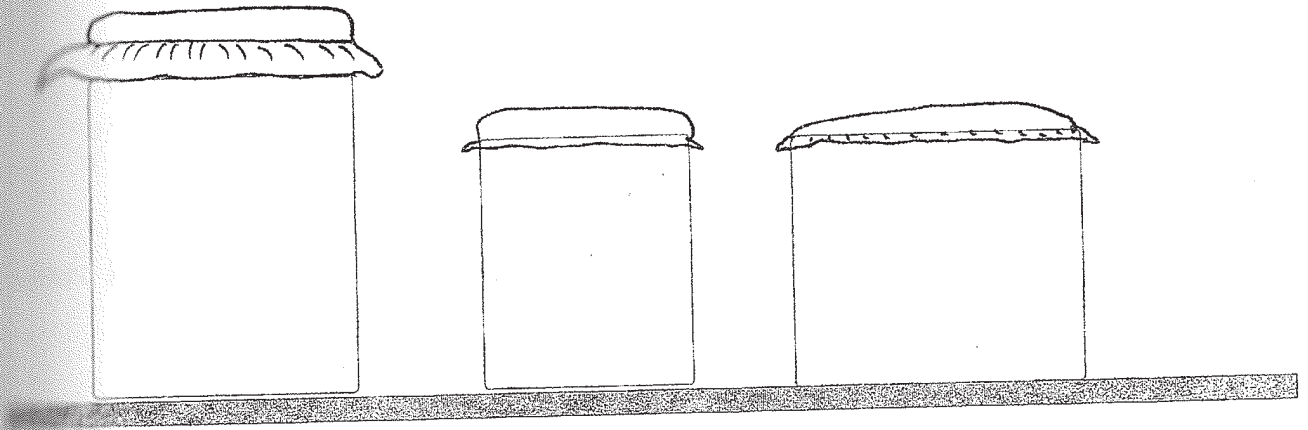

Színezd ki a felfelé néző madarakat!

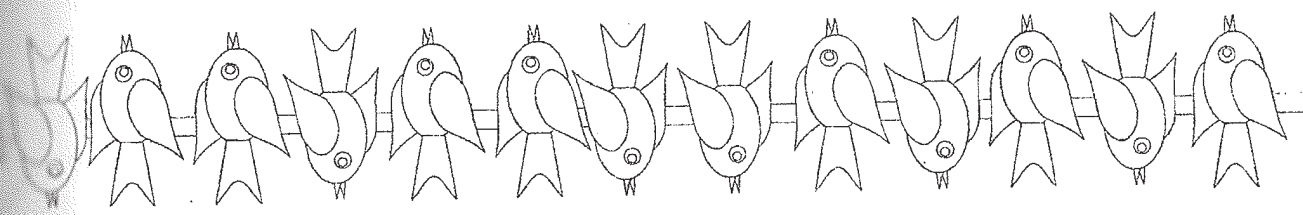

Színezd ki a lefelé haladó esőcseppeket!

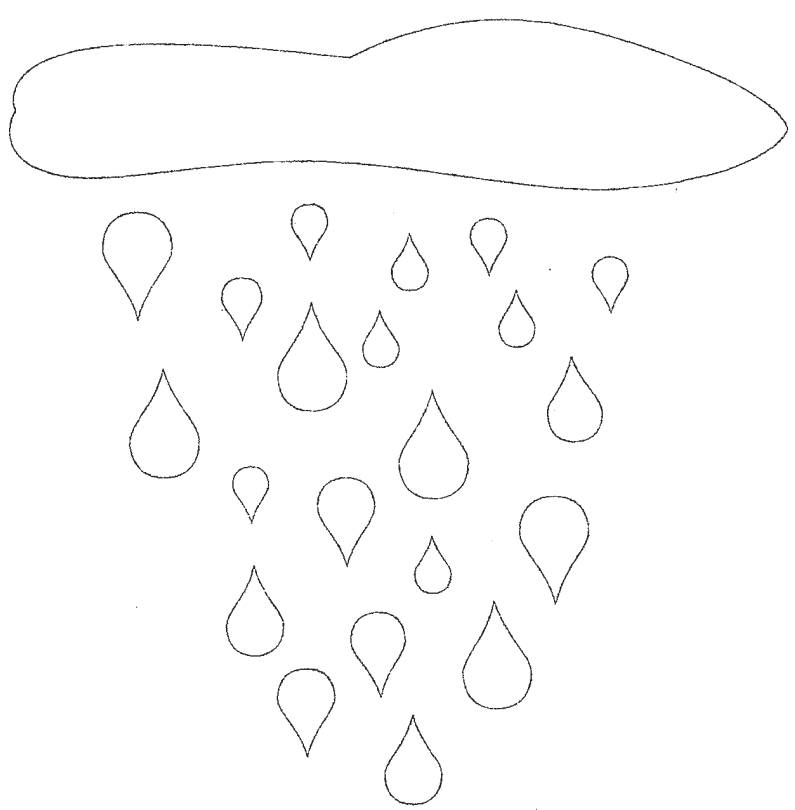

Színezd ki a lefelé úszó halakat!

Rajzold meg a pikkelyeiket is!

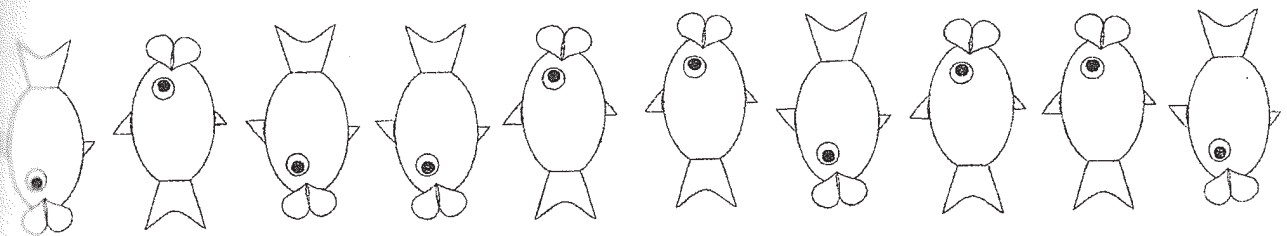

Folytasd a sort!

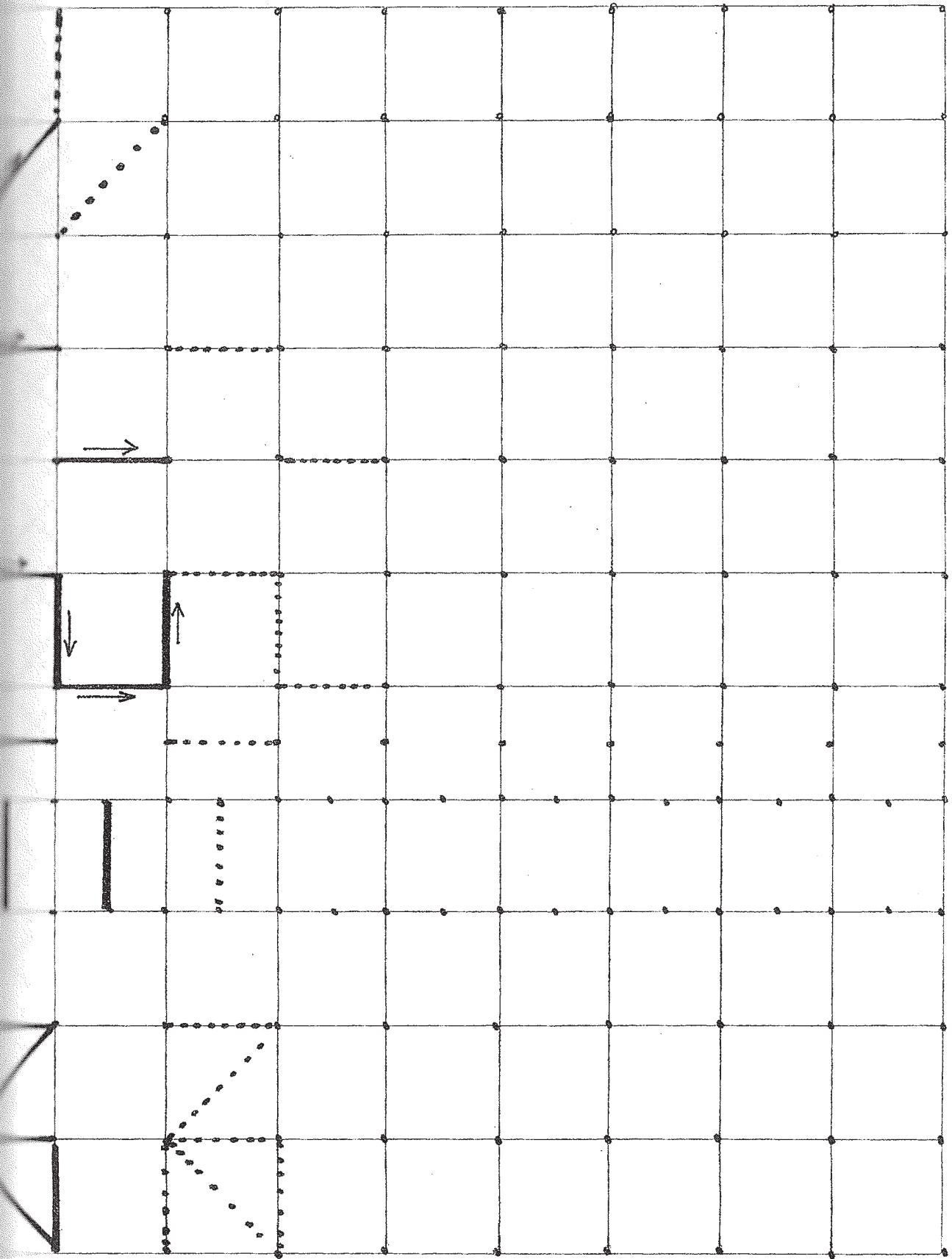

Kösd össze a pontokat, majd színezd ki a kész rajzot!



Vágd ki az 1. és 2. részt, vágd be a szaggatott vonalak mentén, majd fűzd össze a 3. ábra szerint!

1.

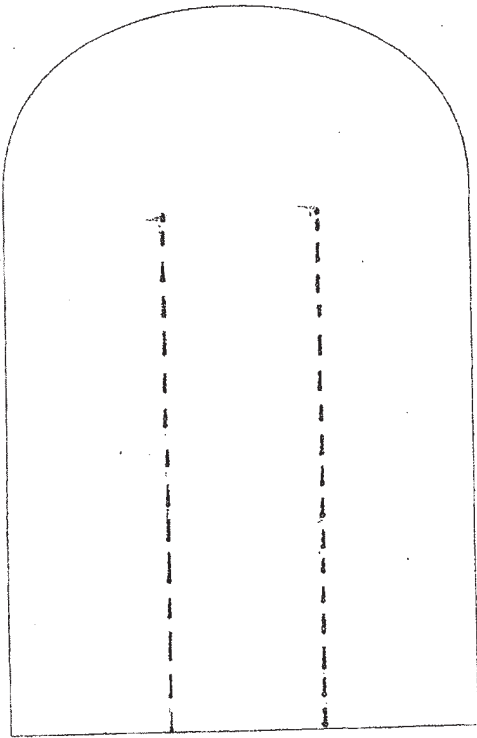

2.

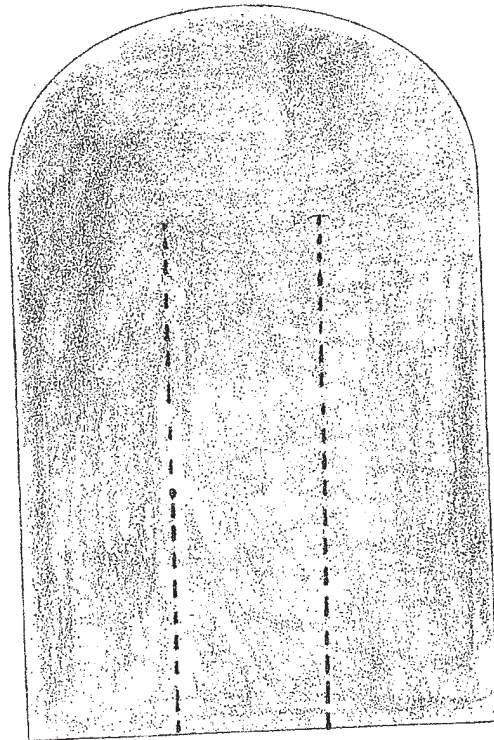

3.

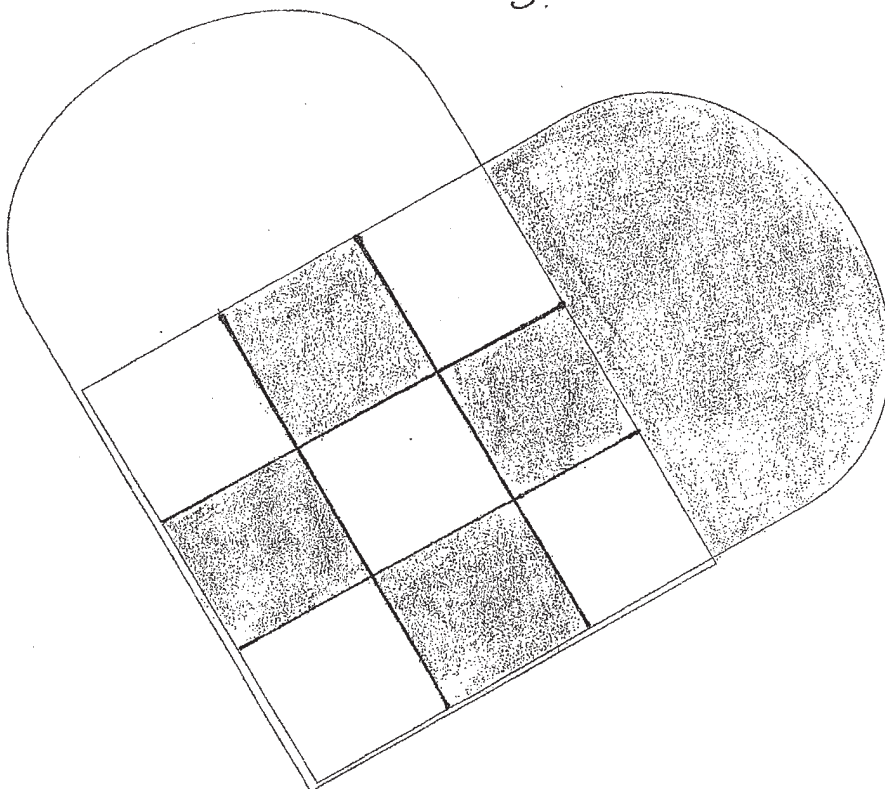

Az első sorba rajzolj vízi, a második sorba szárazföldi, a harmadik sorba pedig légi közlekedési eszközöket!

Csibe a tojásban

Színezd ki az 1. tojást! Ezután vágd ki a vonalak mentén!
A 2. tojást is vágd ki!

1.

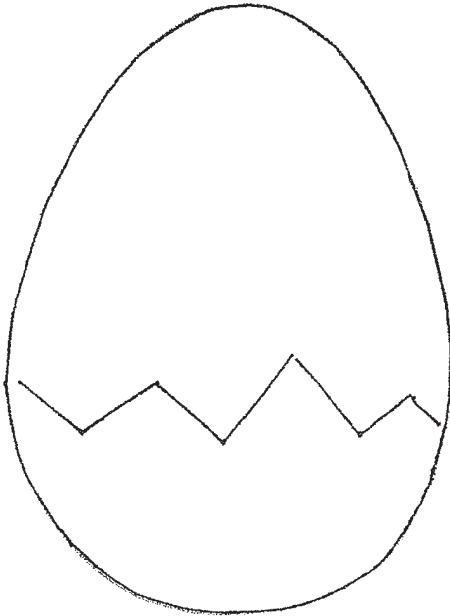

2.

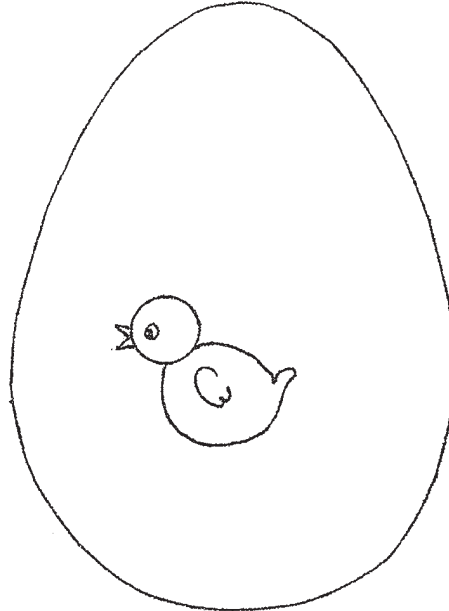

3.

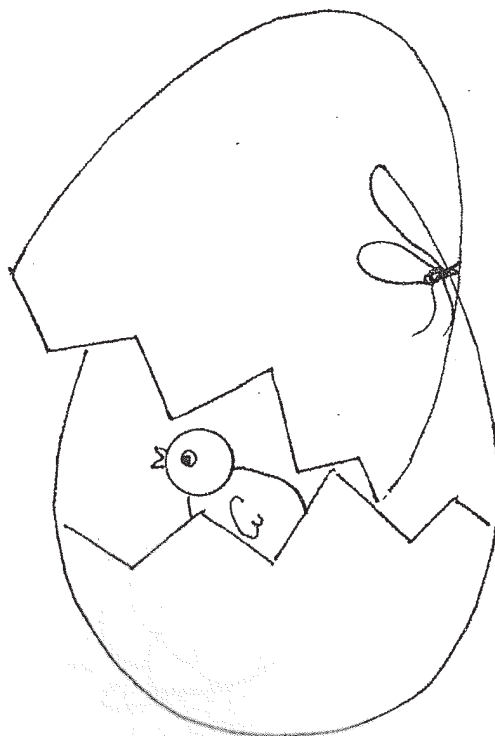

Az 1. tojás alsó felét ragaszd rá a 2. tojásra úgy, ahogy a 3. rajz mutatja!
Az 1. tojás felső részét kis lyukon keresztül kösd hozzá a 2. tojáshoz!

Színezd ki az akváriumban lévő vizet és a növényt!
Színezd ki a halakat, vágd ki őket, majd ragaszd bele az akváriumba!

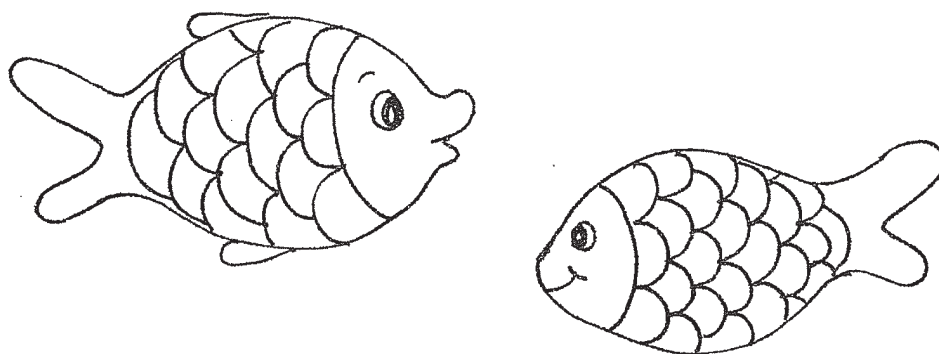
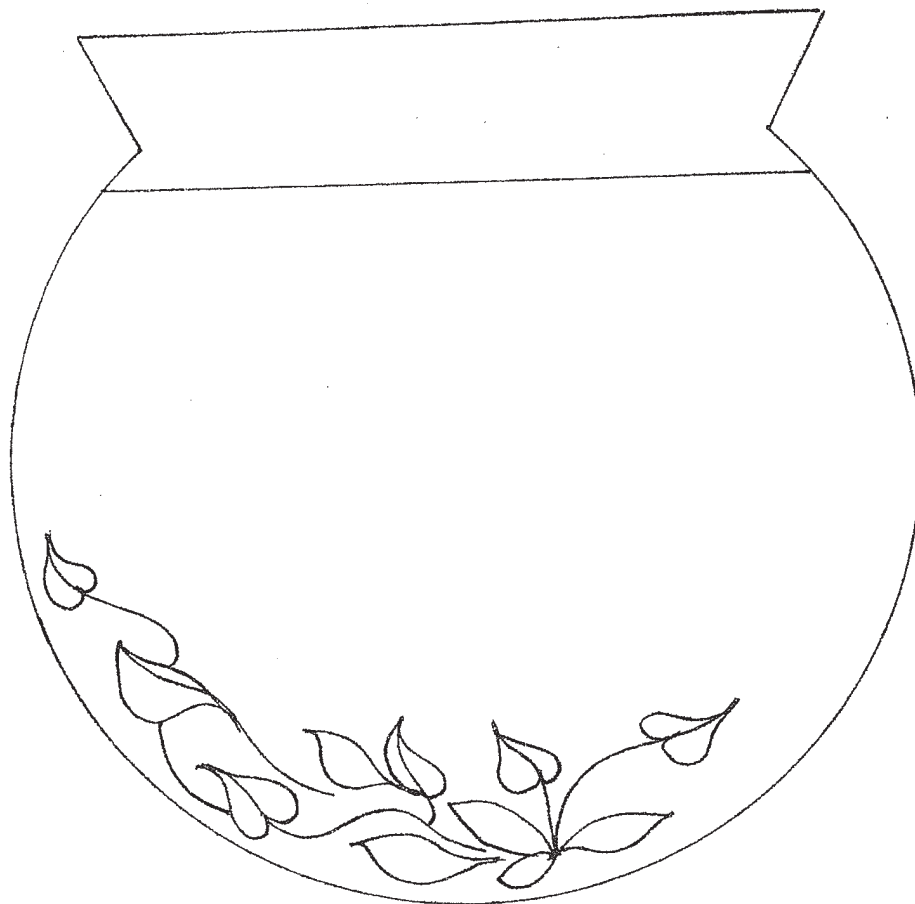

MOZGÓKÉP

Vágd ki a két papírcsíkot!
A bal oldali végüket ragaszd össze.
A felső papírcsíkot csavard rá a ceruzádra.
Ha most a ceruzát jobbra-balra mozgatod,
a fiú ugrálni kezd.

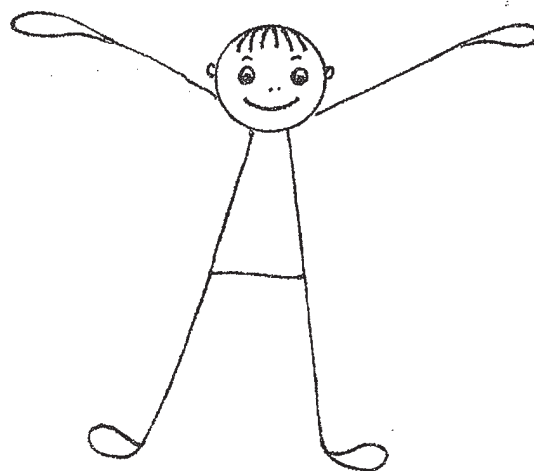
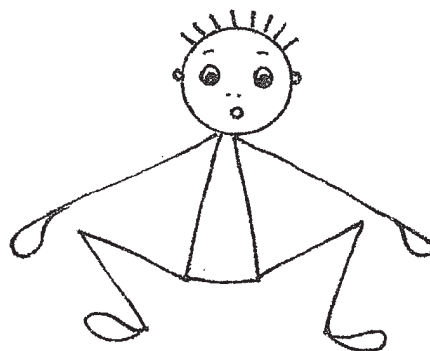
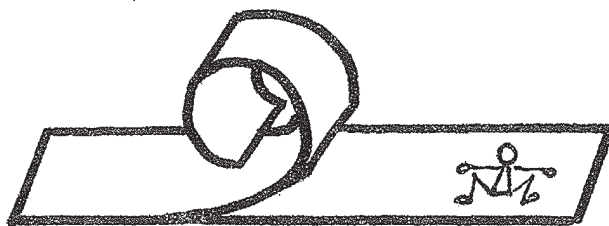

MOZGÓKÉP

Vágd ki a két papírcsíkot!
A bal oldali végüket ragaszd össze.
A felső papírcsíkot csavard rá a ceruzádra.
Ha most a ceruzát jobbra-balra mozgatod,
a lány táncolni kezd.

